

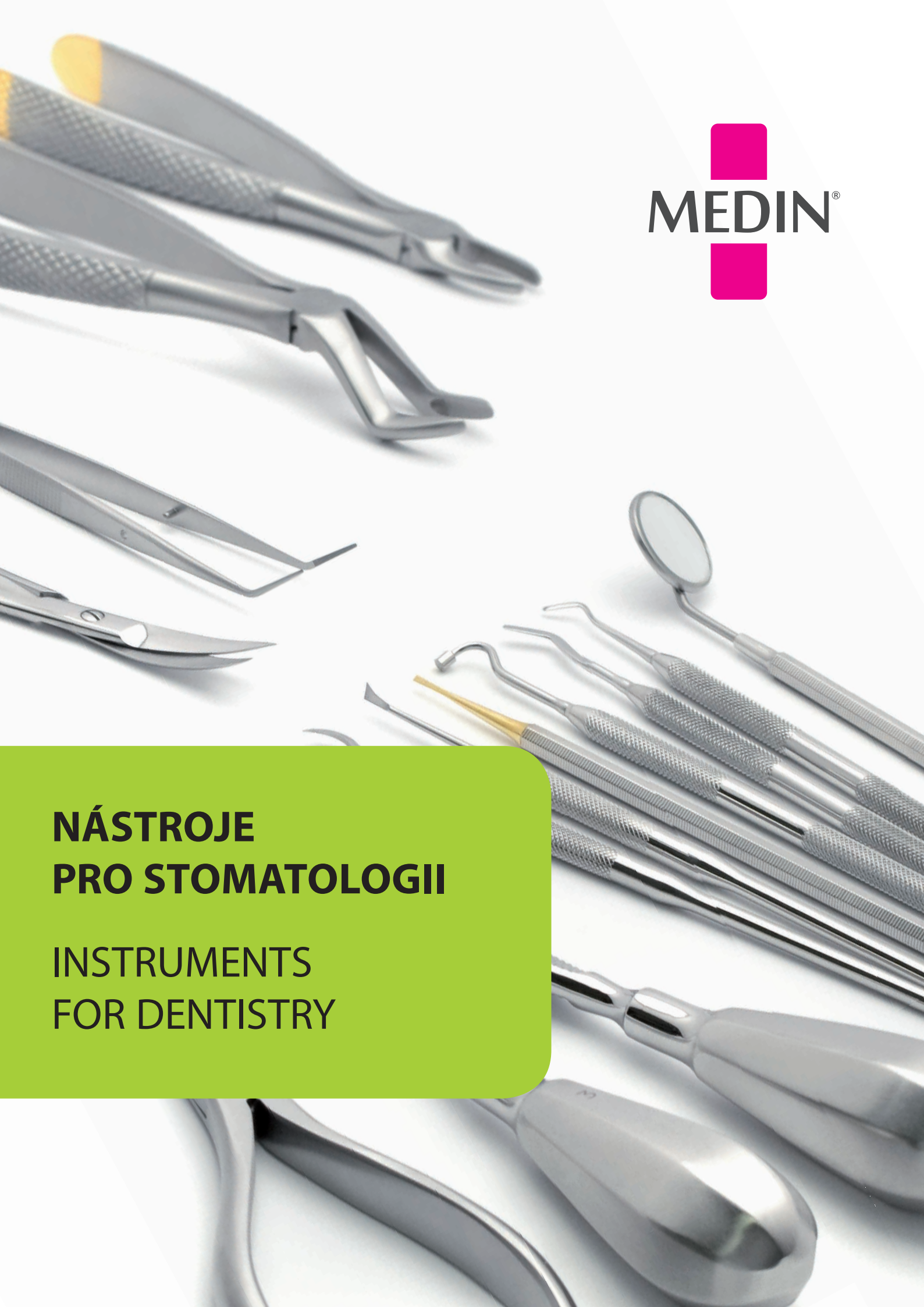

NÁSTROJE PRO STOMATOLOGII

**INSTRUMENTS
FOR DENTISTRY**





MEDIN, a.s.
Vlachovická 619
Nové Město na Moravě
CZ 592 31
Czech Republic
IČ 43378030
DIČ CZ43378030

PRODEJ ČESKÁ REPUBLIKA
tel.: 566 684 327
fax: 566 684 384
e-mail: prodej@medin.cz

EXPORT
phone: +420 566 684 336
fax: +420 566 684 385
e-mail: export@medin.cz

www.medin.cz
www.medin.eu

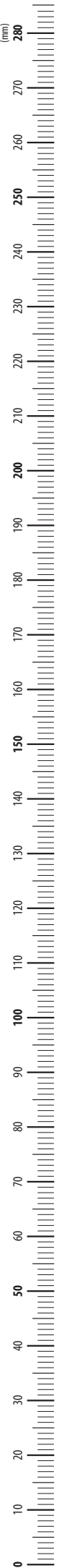



NOTE:

MEDIN catalogue numbers in this catalogue are listed in short form without the prefix.



For example: catalogue number / order number
XXX XX XXXX / 397XXXXXXXXX

Ask your sales representative for the up-to-date conversion table or the price list with complete ordering numbers.

POZNÁMKA:

Katalogová čísla MEDIN jsou v katalogu uvedena ve zkrácené podobě bez předčísí.



Například: katalogové číslo / objednáč číslo
XXX XX XXXX / 397XXXXXXXXX

Aktuální konverzní tabulku nebo ceník s kompletními objednáčými čísly si vyžádejte u svého obchodního zástupce.

© 2020 MEDIN, a.s.; Všechna práva vyhrazena.

Dokument je určen pro obchodní účely MEDIN, a.s., údaje zde uvedené jsou informativního charakteru.

Žádná část tohoto dokumentu nesmí být reprodukována nebo publikována v jakékoliv formě bez předchozího souhlasu MEDIN, a.s. Zobrazení produktů odpovídá aktuálnímu stavu v době vydání tohoto dokumentu. Změny technických parametrů z důvodu dalšího vývoje jsou vyhrazeny.

Tiskové a typografické chyby jsou vyhrazeny.

© 2020 MEDIN, a.s.; All rights reserved.

This document should be used for commercial purposes of MEDIN, a.s.; the data mentioned in the document has informative character. No part of this document can be copied or published in any form without approval of MEDIN, a.s.

The product design may differ from those depicted in these illustrations at the date of issue. Adjustments, made from the reason of further developments of technical parameters, are reserved.

Printing and typographical errors are reserved.

Od zubních vrtáčků po špičkové traumatologické implantáty MEDIN

MEDIN, a.s., je tradičním českým výrobcem lékařských nástrojů a implantátů. Portfolio firmy tvoří produkty pro traumatologii, chirurgii, stomatologii a ortopedii. Společnost dodává své výrobky do desítek zemí celého světa.

Zahájení výroby a budování podniku Chirana

Budoucnost jedné z předních společností České republiky se začala psát dne 29. srpna 1948, kdy byl v Novém Městě na Moravě položen **základní kámen závodu Chirana**. V roce 1949 byla zahájena výroba zubních vrtáčků a fréz pro zubní laboratoře.



V únoru 1950 rozšířila Chirana své **portfolio o chirurgii**. Do výrobního programu bylo zařazeno 25 druhů nejběžnějších chirurgických nástrojů. Ve stejném roce Chirana **poprvé exportuje** své výrobky, a sice do Bulharska, Rumunska a Německa.



Roku 1957 byl podnik rozšířen začleněním firmy Diamantrob, která se zabývala patentově chráněnou výrobou diamantových nástrojů pro zubní lékaře. Chirana pod své vedení vzala také



firmu Pelc-Tyrolka a firmu Koutný, produkující speciální nástroje pro chirurgii. **V roce 1968 byl zřízen holding Chirana Nové Město.**



Počátkem 70. let dominovala snaha o rozšíření výroby. Výsledkem bylo více než 5 milionů vyrobených vrtáčků, počátkem 80. let až 9 milionů vrtáčků. Výroba pokrývala také přes 4 tisíce druhů chirurgických nástrojů.

Do výrobního programu byl v roce 1990 zařazen **obor traumatologie**.



Privatizace a vznik společnosti MEDIN

V roce 1992 byl státní podnik Chirana zařazen do první vlny privatizace a dne 24. března 1992 vznikla akciová společnost MEDIN, právní nástupce státního závodu Chirana. V té době byla firma MEDIN vlastněná 154 zaměstnanci podniku.



Dne 23. března 2006 koupila společnost MEDIN firmu WALTER Medica a následně ji přejmenovala na MEDIN Orthopaedics, a.s. Společnost MEDIN tím rozšířila své **portfolio o ortopedii**.

V roce 2010 byla založena v Rusku dceřiná společnost MEDIN RU. Společnost MEDIN se od roku 2011 prezentuje novým logem.



MEDIN získal v roce 2012 druhou dceřinou společnost, a sice založením firmy MEDIN Slovensko. V roce 2013 došlo k propojení obchodní sítě MEDIN s firmou ProSpon, spol. s r.o. a MEDIN se tak stal výhradním distributorem ortopedických výrobků společnosti ProSpon. Dne 14. března 2014 zvítězil MEDIN, a.s., v soutěži Česká inovace v kategorii Inovativní firma. Ocenění se váže k patentovanému patnímu hřebu C-NAIL.

Školení lékařů

Vedle vlastní kvalitní výzkumné a vývojové základny je nezbytným předpokladem inovativnosti firmy a uplatnění svých produktů v náročných podmínkách trhu schopnost poskytovat kvalitní doprovodné služby. Jednou z těchto služeb, kterým se společnost MEDIN úspěšně věnuje, je pořádání odborných školení, praktických workshopů a seminářů zejména pro mladé lékaře a další zdravotnický personál. Tato vzdělávání probíhají v úzké spolupráci s firmou SOGGIORNO, s.r.o., v rámci celoživotního vzdělávání zdravotníků formou výuky operačních postupů s novými nebo inovovanými produkty firmy. Odborné semináře vedou špičkoví a vysoce uznávaní lékaři zejména v oborech traumatologie, ortopedie a chirurgie, s nimiž se firmě podařilo navázat úspěšnou dlouhodobou spolupráci. Školení je zajišťováno ve školicím středisku přímo v areálu společnosti MEDIN nebo v prostředí klienta.



Jaké hodnoty vám předáváme společně s výrobky?



Každý nástroj či implantát projde během zpracování rukama řady lidí a jeho výroba trvá až několik hodin. Nese tak s sebou i kus naší filozofie a základních hodnot.

Kompletní nákup chirurgických nástrojů. Ze široké nabídky firmy MEDIN jsme si dokázali velmi dobře vybrat."

Mgr. Renáta Michalíčková, staniční sestra op. sálů, Thomayerova nemocnice Praha

Užitná hodnota výrobku

Celá cesta výrobku, od vlastního vývoje po distribuci, má jediný cíl. Dát lékařům do rukou kvalitní nástroj, který usnadní operační zákrok a pomůže při jejich vlastní práci.

"MEDIN instruments are good quality and long life. Most of the items prices are reasonable. We have been dealing with MEDIN for 6 years."

A. A. Zahar, Sala Medical, Oman

Zákazník

Našimi konečnými zákazníky jsou lékaři a zdravotní sestry z oborů chirurgie, traumatologie, ortopedie a stomatology. Snažíme se, aby řešení, která zákazníkům přinášíme, co nejvíce kopírovala jejich potřeby.

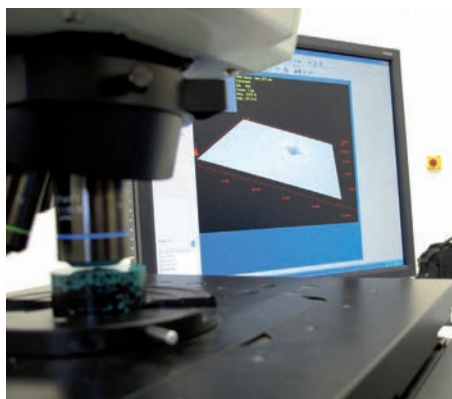

Zkoušky tvrdosti výrobku

"Komunikace je na velké úrovni a skoro vše vyřídí jeden telefonát a to s velkou ochotou."

Markéta Adamová, staniční sestra ORT op. sály, Nemocnice Rudolfa a Stefanie Benešov

Naše okolí

Uvědomujeme si, že každá lidská činnost přináší změny v životním prostředí. Proto aplikujeme systém environmentálního managementu EMS. V rámci modelu Plan – Do – Check – Act Cycle neustále zkoumáme jednotlivé postupy ve firmě a hledáme ekologicky šetrnější varianty.



Testování nového instrumentária.



Sídlo naší společnosti se nachází v Novém Městě na Moravě, v dějišti řady sportovních událostí.

Certifikáty



ISO 13485:2016

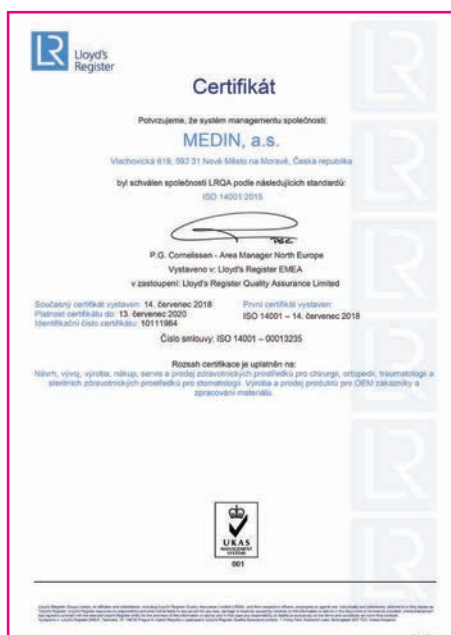

ISO 14001:2015



CE (93/42/EHS)

From tooth drills to top-class traumatology implants MEDIN

MEDIN, a.s., is a traditional Czech producer of medical instruments and implants. The company's portfolio consists of products for traumatology, surgery, dentistry and orthopaedics. The company exports its products to dozens of countries around the world.

The start of production and building Chirana

The future of one of the leading companies in the Czech Republic began on 29 August 1948, when the **foundation stone of the** Chirana works was laid in Nové Město na Moravě. In 1949, production started on dental drills and milling cutters for dental laboratories.



In February 1950 Chirana expanded its **portfolio to surgery**. 25 of the most common surgical instruments were included in the production programme. In the same year Chirana **first exported** its products, namely to Bulgaria, Romania and Germany.



In 1957 the company expanded by incorporating Diamantrob, which was involved in the patented production of diamond tools for dentists. Chirana



also took Pelc-Tyrolka and Koutný, companies producing special tools for surgery, under its management. **The Chirana Nové Město holding was set up in 1968.**



The early 1970s were dominated by an endeavour to expand production. The result was the manufacture of over 5 million drills, in the early 80's this had increased to 9,000,000 drills. Production covered over 4,000 kinds of surgical instruments. The field of traumatology was introduced into the production programme in 1990.



Privatization and the emergence of MEDIN

In 1992, the state enterprise Chirana was included in the first wave of privatization and on 24 March 1992 the joint-stock company MEDIN was founded, the legal successor to the state-owned Chirana. At the time, MEDIN was owned by 154 company employees.



On 23 March 2006, MEDIN bought WALTER Medica and subsequently changed its name to MEDIN Orthopaedics, a.s. This allowed MEDIN to expand its **portfolio to orthopaedics.**

In 2010 a subsidiary, MEDIN RU, was founded in Russia. Since 2011 MEDIN has had a new logo.



In 2012 MEDIN gained a second subsidiary, namely through the founding of MEDIN Slovensko. In 2013 the MEDIN business network was linked to ProSpon, spol. s r.o. and MEDIN became the exclusive distributor of orthopaedic products for ProSpon. On 14 March 2014 MEDIN, a.s., won the Czech Innovation contest in the Innovative Company category. The award is for C-NAIL a patented calcaneal nail.

Training doctors

Besides its high-quality research and development programme, the provision of good-quality services is a prerequisite of a company's innovation and its ability to sell its products in the demanding conditions of today's market. One of these services, which MEDIN has had great success in, is the organization of professional training, practical workshops and seminars especially for young physicians and other medical personnel. This training takes place in close cooperation with SOGGIORNO, s.r.o., as part of lifelong education for health care professionals and takes the form of training in operating procedures with new or innovated products from the company. Professional seminars are led by leading and highly respected doctors, in particular in the fields of orthopaedics, traumatology and surgery, with whom the company has been able to establish successful, long-term cooperation. Training is provided in the training centre directly at MEDIN or at the client's premises.



What is the added value we offer with our products?



During processing, each instrument or implant passes through the hands of a number of people and takes up to several hours to produce. As such it carries a part of our philosophy and basic principles with it.

"Our operating theatres are brand new which meant purchasing a full range of surgical instruments. We were spoilt for choice from the wide offer range provided by MEDIN."

MSc Renáta Michalčková, Head Nurse for operating theatre at Thomayer's Hospital, Prague

Customer

Our end customers are doctors and nurses from the fields of surgery, traumatology, orthopaedics and stomatology. We try to ensure that the solutions we deliver to customers match their needs as closely as possible.



Testing of new instrumentaria.

Useful product value

Throughout the journey of making a product, from actual development right up until distribution, there is only one goal – to provide doctors with a quality instrument which will facilitate the operation procedure and assist them in their own work.

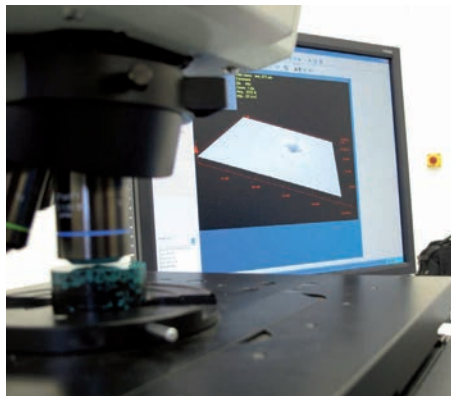

Tests on product hardness

"Communication is of the highest level and is almost always dealt with over one phone call and with a great sense of willingness"

Markéta Adamová, Head Nurse ORT operating theatre, Rudolf and Stephanie Hospital, Benešov

"MEDIN instruments are good quality and long lasting. Most prices of items are reasonable. We have been dealing with Medin for 6 years."

A. A. Zahar, Sala Medical, Oman

Our surroundings

We are aware that all human activity is accompanied by changes in our environment. For this reason we have put in place a system of environmental management called EMS. As part of our Plan – Do – Check – Act Cycle model, we are constantly exploring individual processes in the company and looking for options which demonstrate greater consideration to the environment.



Our head offices are located in Nové Město na Moravě, venue of sporting events.

Certificates

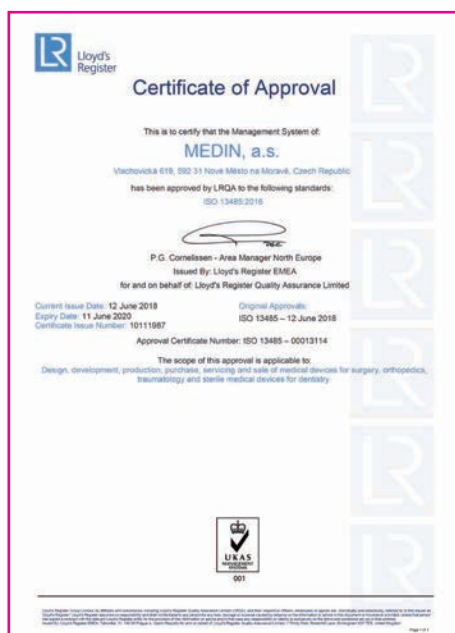

ISO 13485:2016

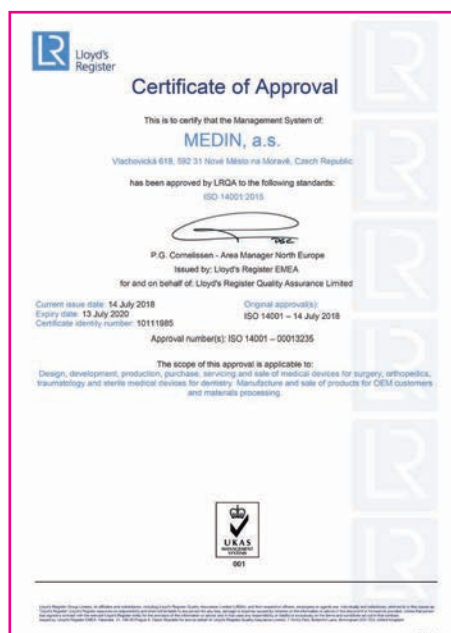

ISO 14001:2015



CE (93/42/EEC)

A	Extrakce a chirurgie	Extraction and Surgery	9–70
B	Diagnostika	Diagnostics	71–76
C	Záchovná stomatologie	Restorative	77–98
D	Parodontologie	Periodontia	99–112
E	Laboratoř	Laboratory	113–132
F	Sterilizace a pomocné vybavení	Sterilization and Accessories	133–146
	Číselný rejstřík	Numerical Index	147–168
	Jmenný rejstřík	Alphabetical Index	169–174

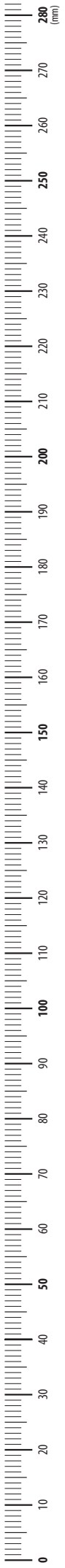

A series of horizontal lines extending across the page, providing a template for writing or drawing. The lines are evenly spaced and correspond to the millimeter markings on the ruler.

A

EXTRAKCE A CHIRURGIE
EXTRACTION AND SURGERY



Kleště extrakční	Extraction Forceps	11–15
Kleště štípací	Bone Rongeurs	16–18
Kleště úchopné	Grasping Forceps	19
Páčidla	Elevators	20
Páky extrakční	Root Elevators	21–25
Škrabky	Raspatories	26
Pilníky	Rasps	27
Dláta	Chisels	28
Kladívka	Mallets	29
Háky	Hooks, Retractors	30–35
Chrániče prstu	Finger Protectors	35
Rozvěrače úst	Mouth Retractors	36
Lžičky	Bone Curettes, Spoons	37–38
Nástroje řezné	Cutting Instruments	39
Držátka skalpelových čepelk	Scalpel Handles	40
Skalpelové čepelky	Scalpel Blades	41
Svorky	Clamps, Forceps	42–47
Jehelce	Needle Holders	48–51
Zavaděče	Introducers	52
Nůžky	Scissors	53–61
Pinzety	Forceps	62–68

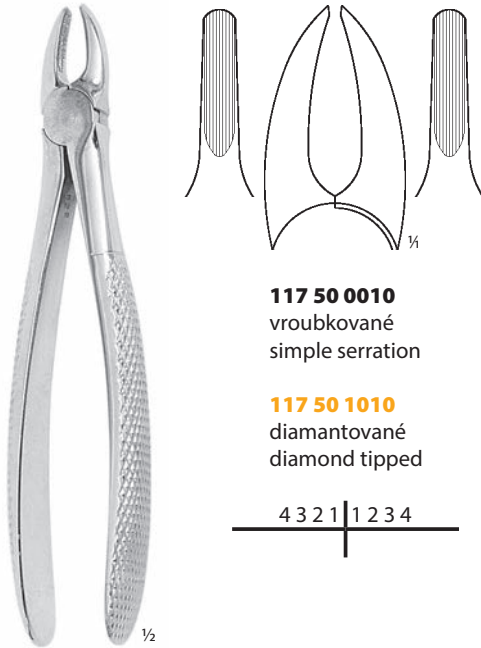

117 50 0010
vroubkované
simple serration

117 50 1010
diamantované
diamond tipped

4 3 2 1 | 1 2 3 4

1/2

D2
na horní malé řezáky
for upper laterals
16,8 cm

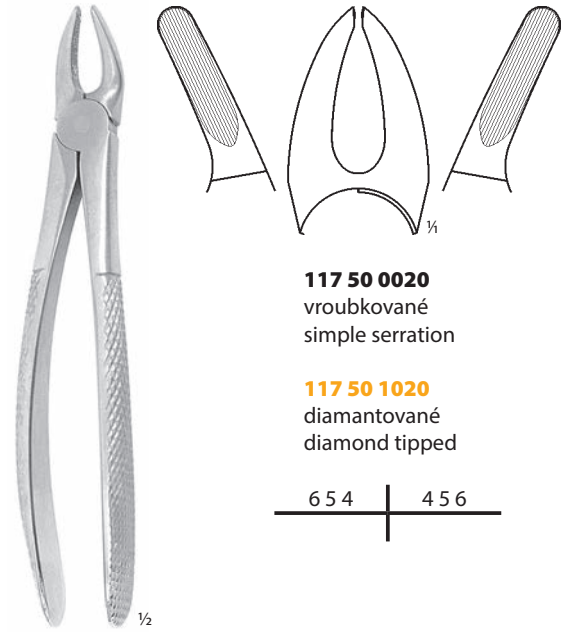

117 50 0020
vroubkované
simple serration

117 50 1020
diamantované
diamond tipped

6 5 4 | 4 5 6

1/2

D7
na horní premoláry
for upper premolars
16,4 cm

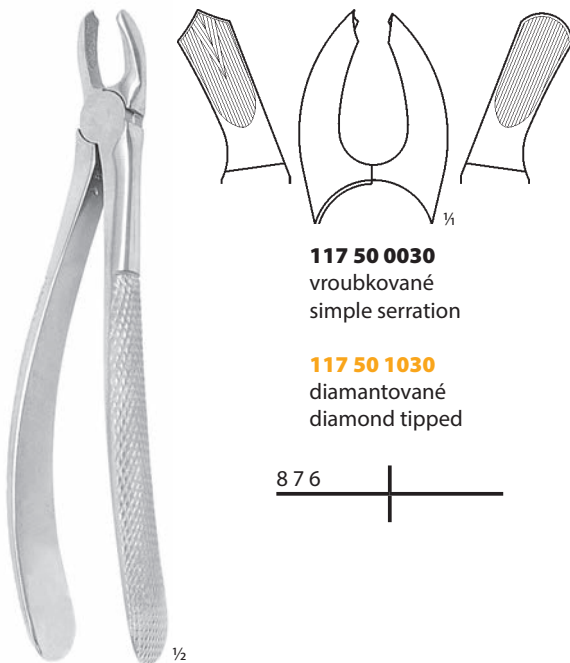

117 50 0030
vroubkované
simple serration

117 50 1030
diamantované
diamond tipped

8 7 6 |

1/2

D17
na horní moláry pravé
for right upper molars
17,2 cm

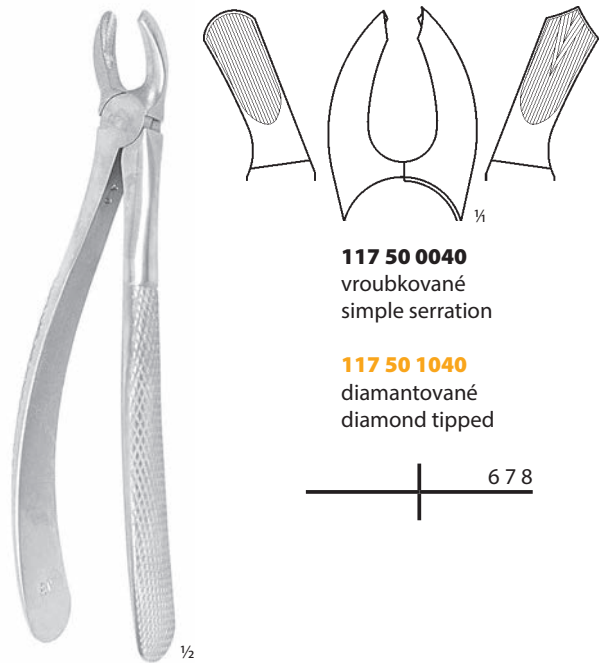

117 50 0040
vroubkované
simple serration

117 50 1040
diamantované
diamond tipped

| 6 7 8

1/2

D18
na horní moláry levé
for left upper molars
17,2 cm

KLEŠTĚ EXTRAKČNÍ
EXTRACTION FORCEPS

117 50 0150
vroubkované
simple serration

117 50 1150
diamantované
diamond tipped



D13
na dolní premoláry
for lower premolars
15,0 cm



117 50 0160
vroubkované
simple serration

117 50 1160
diamantované
diamond tipped



D22
na dolní moláry
for lower molars
15,0 cm



117 50 0200
vroubkované
simple serration

117 50 1200
diamantované
diamond tipped



D33
na dolní kořeny široké
for lower roots broad
14,8 cm



117 50 0190
vroubkované
simple serration

117 50 1190
diamantované
diamond tipped



D33A
na dolní kořeny úzké
for lower roots
14,8 cm



D30S
na horní kořeny
for upper roots
15,0 cm

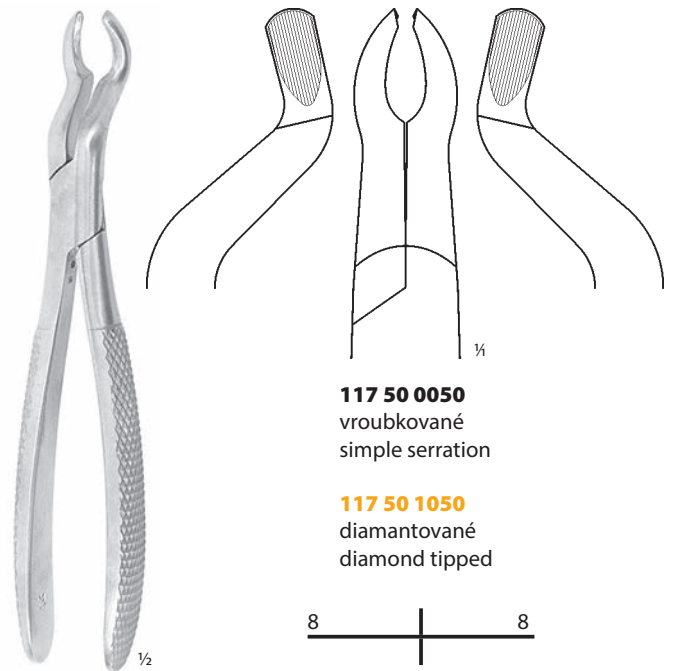

D67
na horní 3. moláry
for upper wisdoms
17,4 cm



D51A
bajonetové úzké
for upper roots narrow
18,2 cm

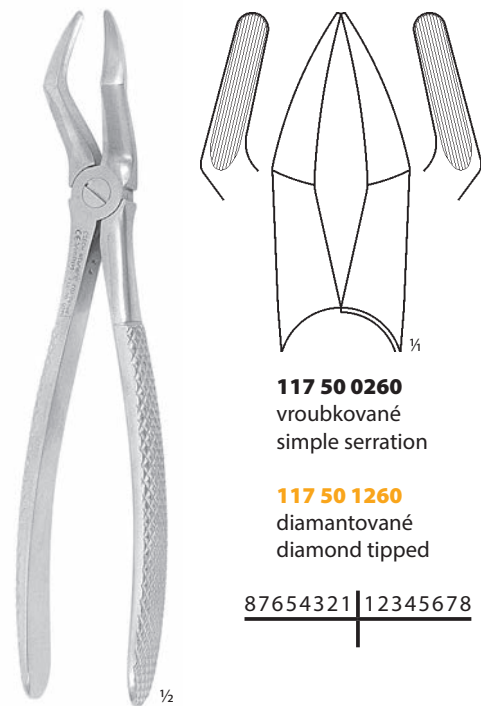

D51
bajonetové široké
for upper roots broad
18,2 cm

KLEŠTĚ EXTRAKČNÍ
EXTRACTION FORCEPS

117 50 0170
vroubkované
simple serration

117 50 1170
diamantované
diamond tipped

D73
na dolní moláry
for lower molars
15,0 cm



117 50 0350
vroubkované
simple serration

117 50 1350
diamantované
diamond tipped

D74
na dolní kořeny
for lower roots
15,0 cm

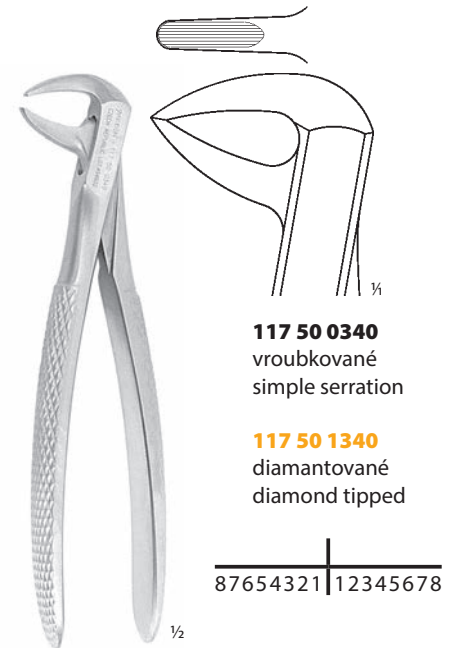

117 50 0340
vroubkované
simple serration

117 50 1340
diamantované
diamond tipped

D74M
na dolní kořeny
for lower roots
15,0 cm



117 50 0330
vroubkované
simple serration

117 50 1330
diamantované
diamond tipped

D74N
na dolní kořeny
for lower roots
15,0 cm

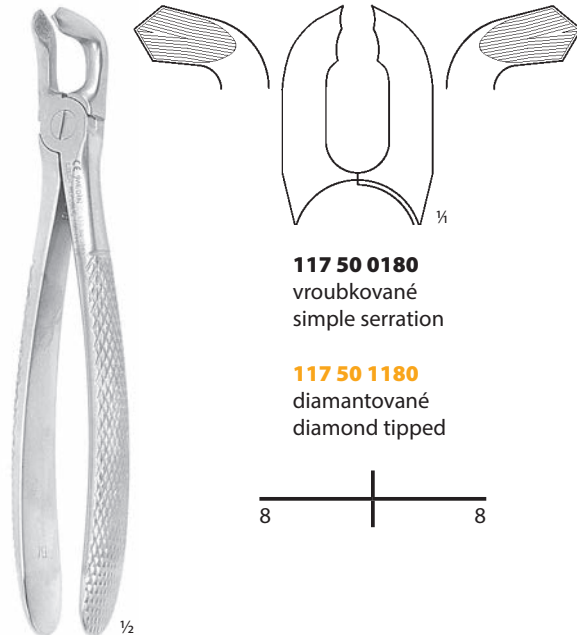

117 50 0180
vroubkované
simple serration

117 50 1180
diamantované
diamond tipped

D79
na dolní 3. moláry
for lower wisdoms
16,5 cm



D339
na dolní moláry
for lower molars
10,7 cm



D342
na horní moláry
for upper molars
11,7 cm

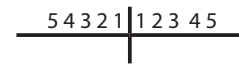

KLEŠTĚ K ODSTRANĚNÍ KOŘENOVÝCH NÁSTROJŮ
FORCEPS FOR EXTRACTION OF ROOT INSTRUMENTS



117 51 0600
rovné
straight
13,5 cm



117 51 1600
rovné, diamantované
straight, diamond tipped
13,5 cm



117 51 0610
zahnuté
curved
13,5 cm



117 51 1610
zahnuté, diamantované
curved, diamond tipped
13,5 cm

KLEŠTĚ ŠTÍPACÍ
BONE RONGEURS

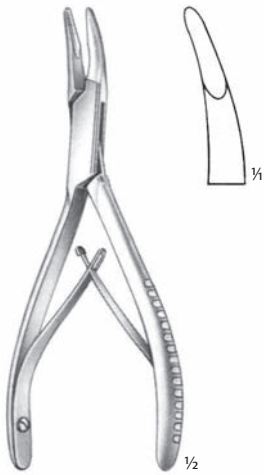

MINI-FRIEDMAN
116 91 0017
12,0 cm



FRIEDMAN
116 91 0514
14,0 cm

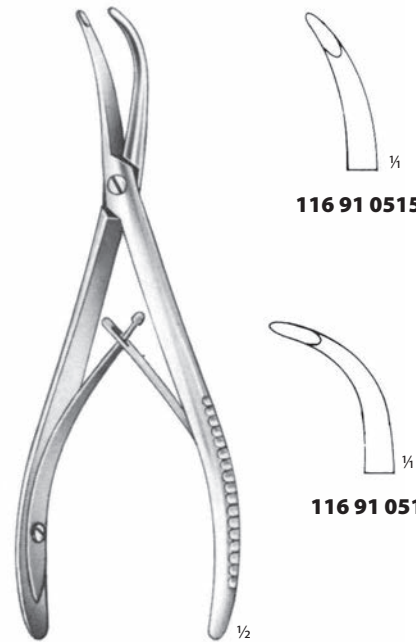

STELLBRINK
17,0 cm

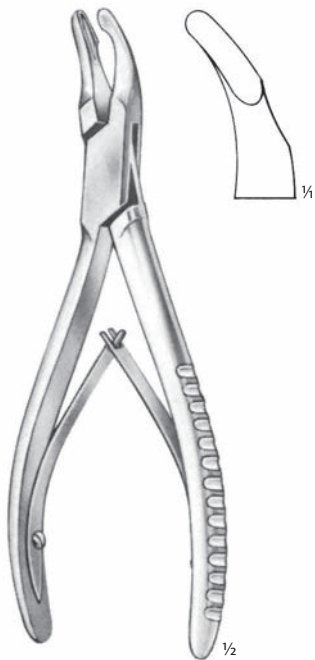

CLEVELAND
116 91 0518
17,0 cm



BLUMENTHAL
15,5 cm



116 91 0522

116 91 0523

116 91 0524

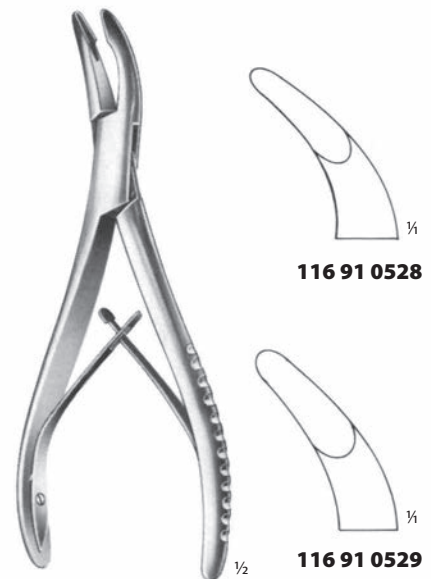

LUER
15,0 cm

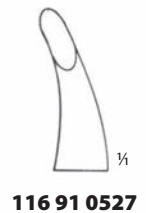

116 91 0527



116 91 0528

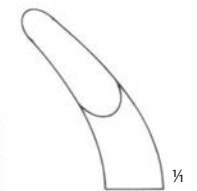

116 91 0529



LUER
116 08 0030
rovné
straight
17,0 cm



LUER
116 08 0070
zahnuté
curved
15,0 cm

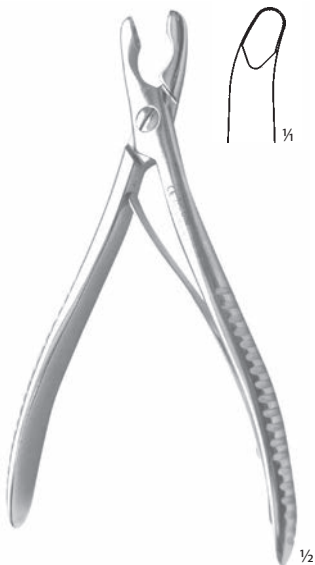

LUER
116 08 0080
zahnuté
curved
14,5 cm



JANSEN
116 29 0410
zahnuté
curved
18,0 cm
Fig. 2

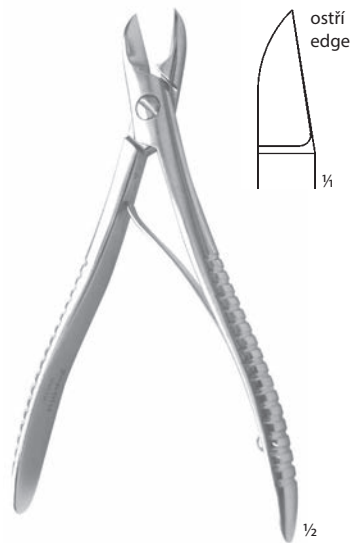

LISTON
116 08 0410
rovné
straight
14,0 cm

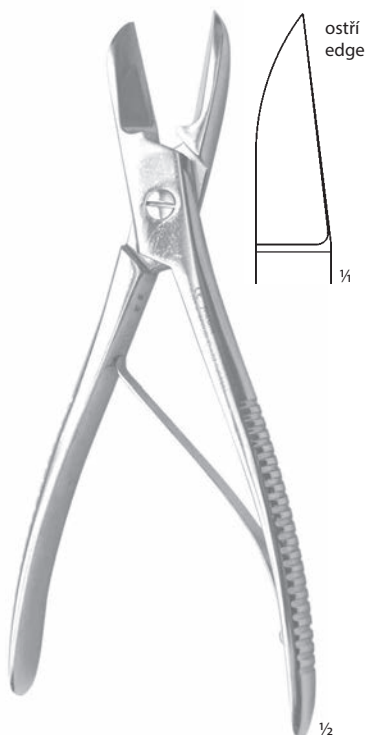

LISTON
116 08 0440
rovné
straight
19,0 cm

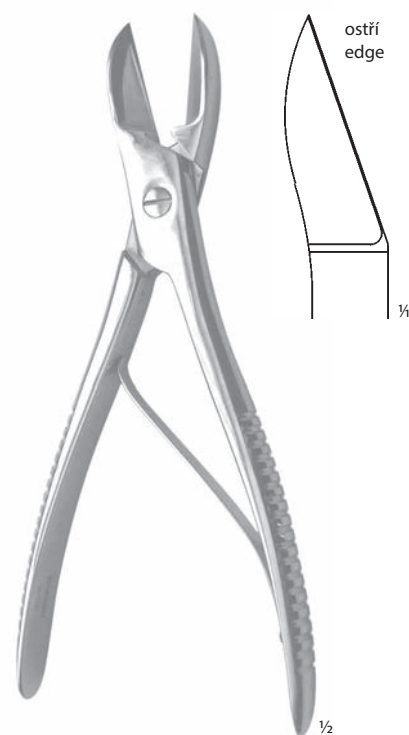

LISTON
116 08 0450
zahnuté
curved
19,0 cm



COLLIN
117 31 0010
16,7 cm

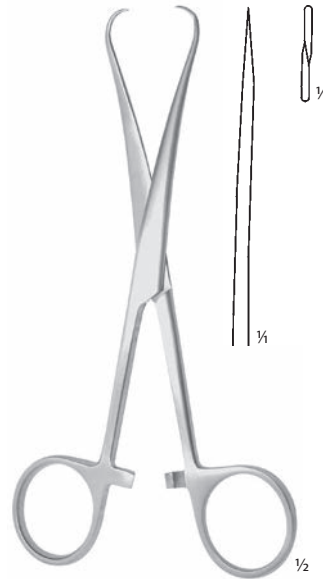

LÖBKER
117 31 0030
15,0 cm

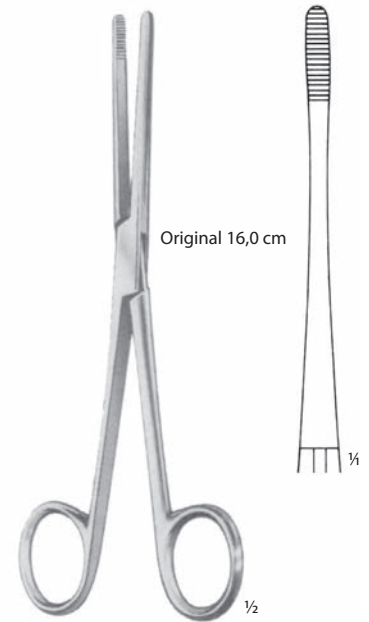

LISTER
117 91 0001 13,0 cm
117 91 0002 16,0 cm
117 91 0003 18,0 cm

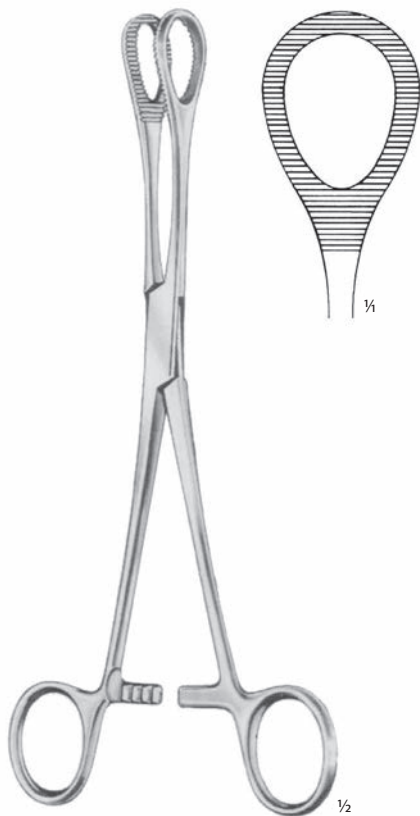

HEYWOOD-SMITH
117 91 0038
21,0 cm



HEYWOOD-SMITH
117 91 0039
25,0 cm



COLLIN
117 91 0033
24,0 cm

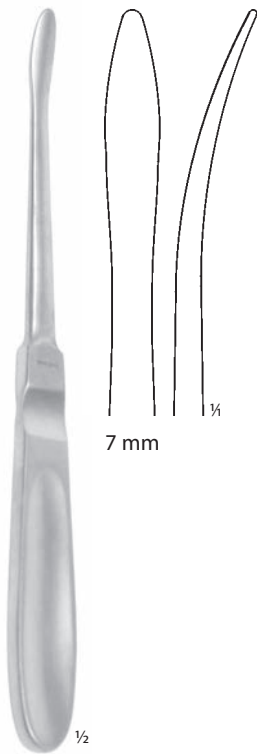

LANGENBECK
123 08 0010
19,5 cm
Fig. 1

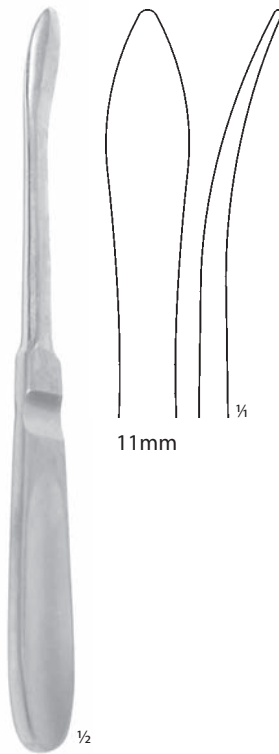

LANGENBECK
123 08 0020
19,5 cm
Fig. 2

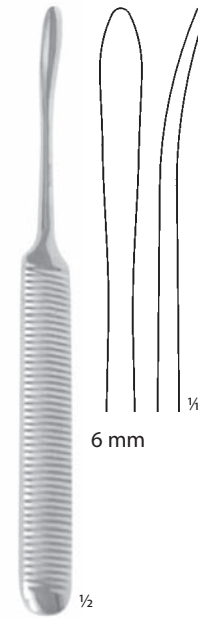

WILLIGER
123 08 0030
16,0 cm
Fig. 1

PÁČIDLA NOSNÍ
NASAL ELEVATORS



FREER
123 30 0030
17,9 cm

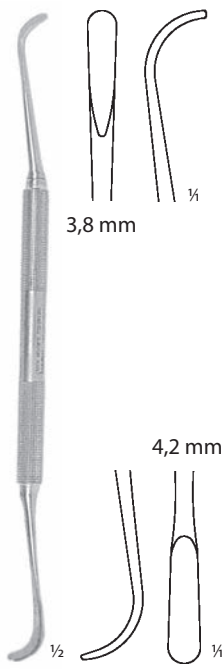

123 99 0084
17,0 cm

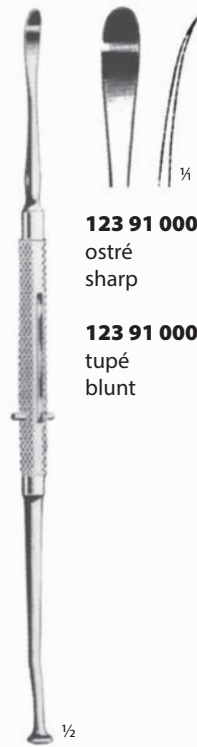

123 91 0006
ostré
sharp

123 91 0007
tupé
blunt

FREER
19,0 cm



FREER
123 91 0008
18,0 cm

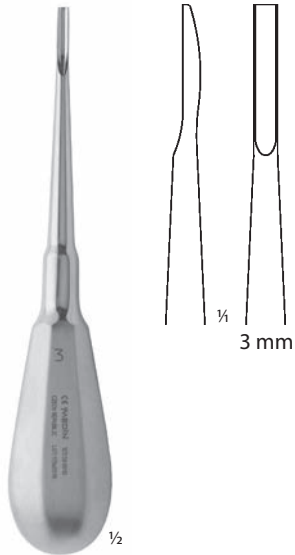

BEIN
123 50 0010
rovná
straight
14,5 cm



BEIN
123 50 0011
rovná
straight
16,5 cm

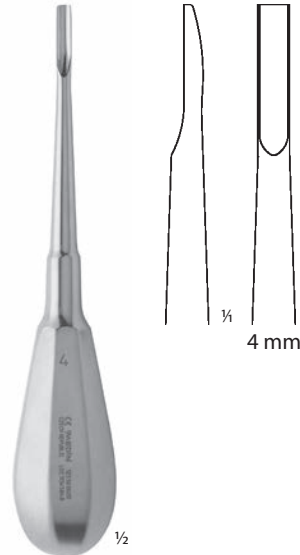

BEIN
123 50 0020
rovná
straight
14,5 cm



BEIN
123 50 0021
rovná
straight
16,5 cm

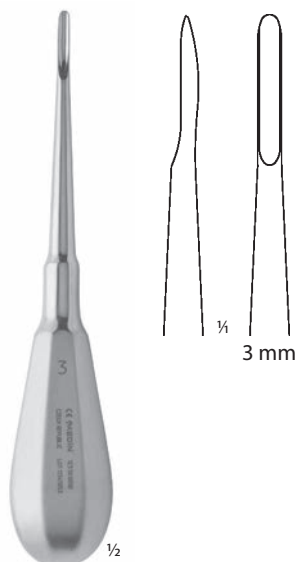

BEIN
123 50 0050
oblouková
embowed
14,5 cm



BEIN
123 50 0051
oblouková
embowed
16,5 cm

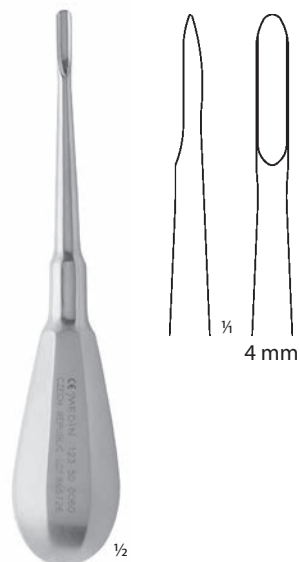

BEIN
123 50 0060
oblouková
embowed
14,5 cm

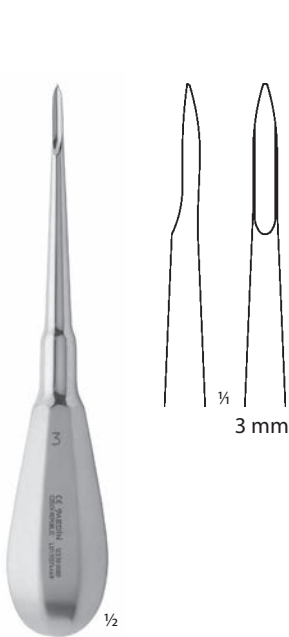

BEIN
123 50 0061
oblouková
embowed
16,5 cm

PÁKY EXTRAKČNÍ
ROOT ELEVATORS

BEIN
123 50 0080
rovná, jemná
straight, fine
14,5 cm



BEIN
123 50 0081
rovná, jemná
straight, fine
16,5 cm

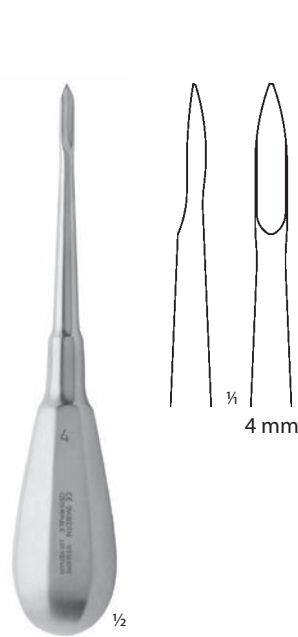

BEIN
123 50 0090
rovná, jemná
straight, fine
14,5 cm



BEIN
123 50 0091
rovná, jemná
straight, fine
16,5 cm

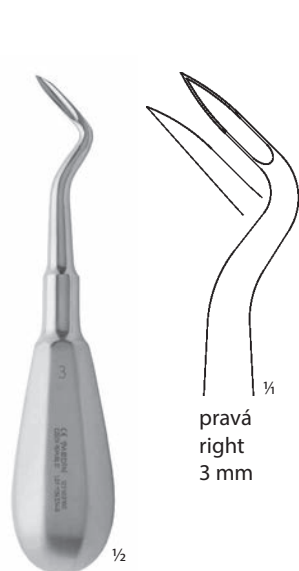

FLOHR
123 50 0100
hrotnatá, ostrá
pointed, sharp
13,0 cm



FLOHR
123 50 0101
hrotnatá, ostrá
pointed, sharp
15,0 cm



FLOHR
123 50 0110
hrotnatá, ostrá
pointed, sharp
13,0 cm



FLOHR
123 50 0111
hrotnatá, ostrá
pointed, sharp
15,0 cm

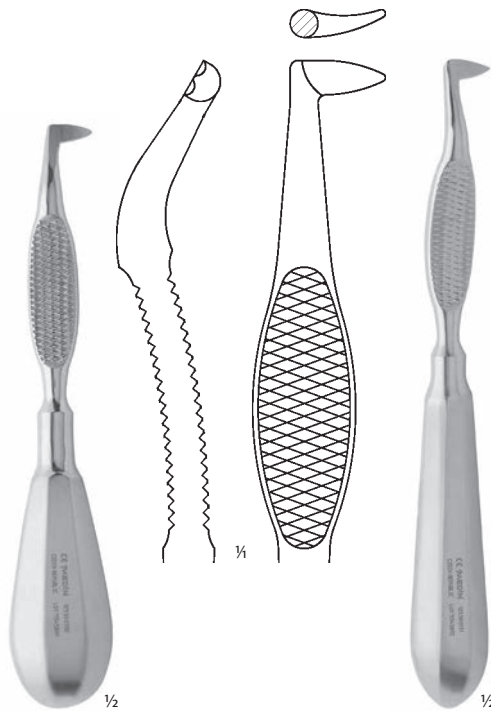

SCHLEMMER
123 50 0130
pravá
right
15,1 cm



SCHLEMMER
123 50 0131
pravá
right
17,1 cm

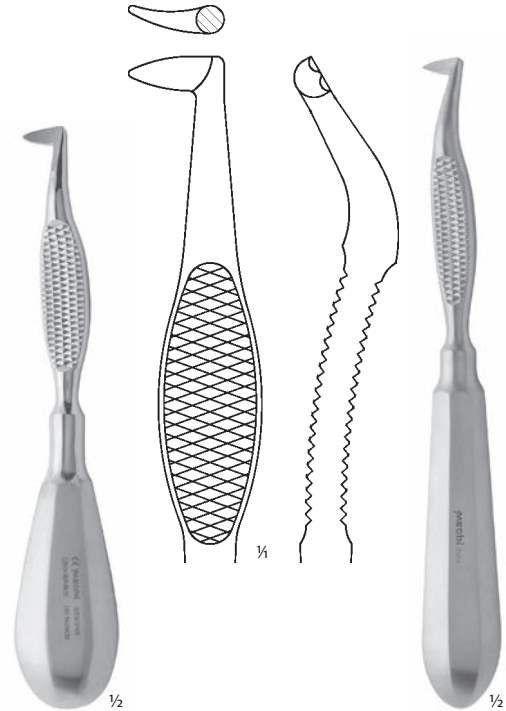

SCHLEMMER
123 50 0140
levá
left
15,1 cm



SCHLEMMER
123 50 0141
levá
left
17,1 cm

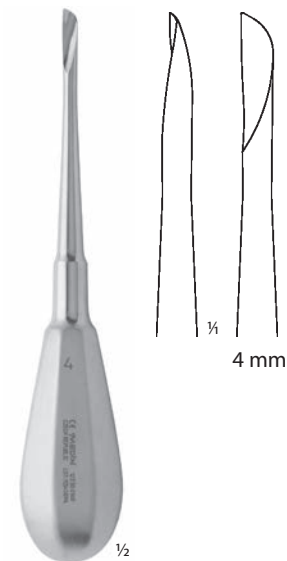

123 50 0160
rovná, pravá
straight, right
14,5 cm

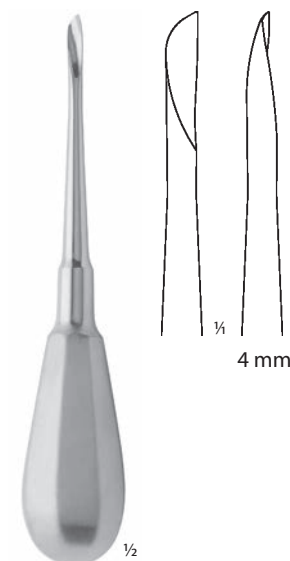

123 50 0170
rovná, levá
straight, left
14,5 cm

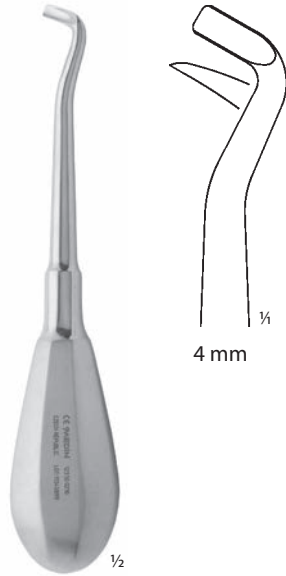

ŠPINAR
123 50 0210
přední
frontal
14,8 cm

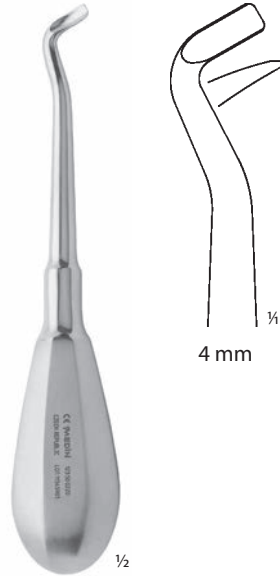

ŠPINAR
123 50 0220
zadní
retral
14,8 cm

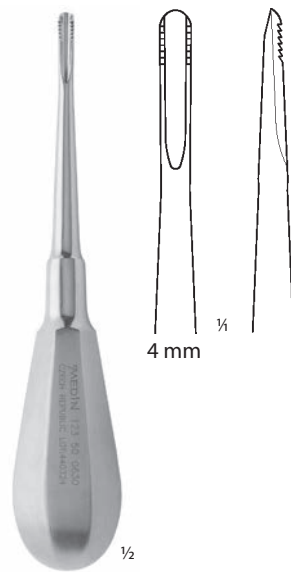

123 50 0630
se zuby, rovná
with saw, straight
14,5 cm

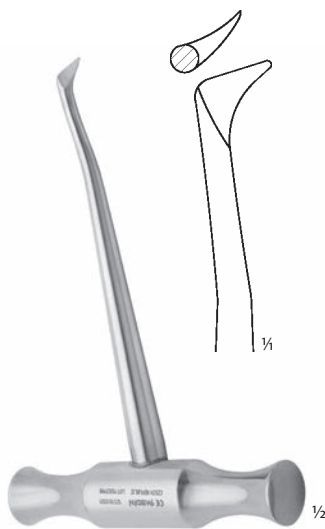

BARRY
123 50 0301
pravá
right
12,4 cm

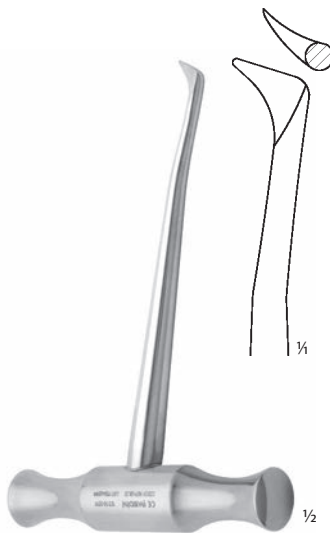

BARRY
123 50 0311
levá
left
12,4 cm

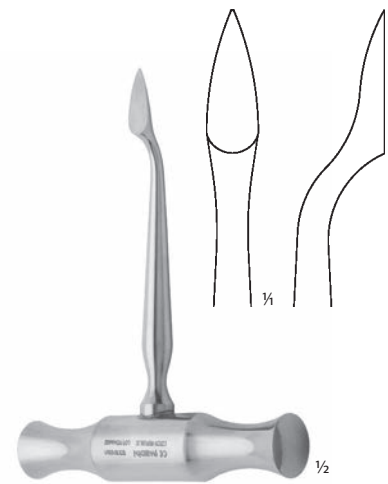

LECLUSE
123 50 0361
10,8 cm

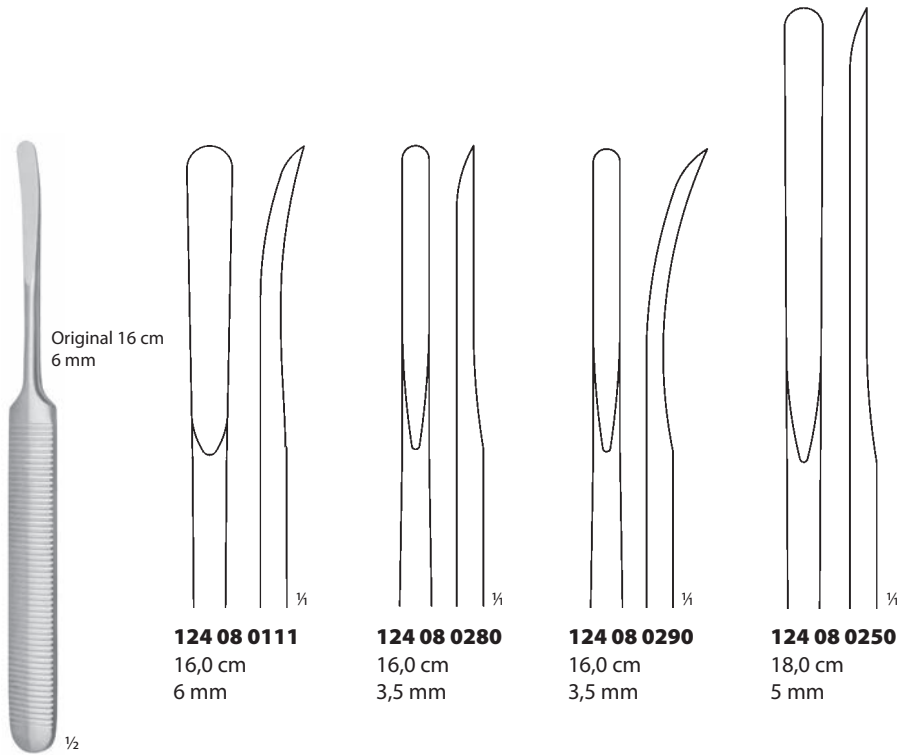

WILLIGER
16,0 cm

124 08 0111
16,0 cm
6 mm

124 08 0280
16,0 cm
3,5 mm

124 08 0290
16,0 cm
3,5 mm

124 08 0250
18,0 cm
5 mm



LANGENBECK
124 08 0120
20,5 cm

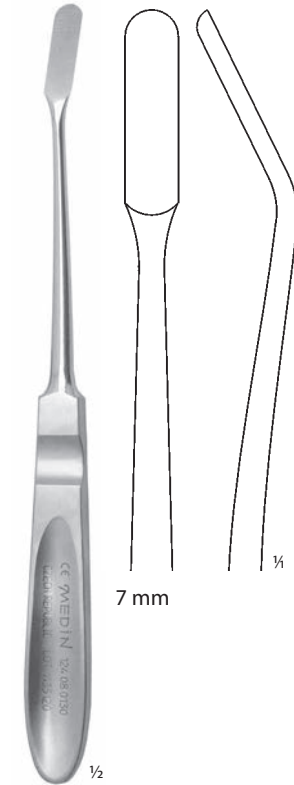

LANGENBECK
124 08 0130
20,4 cm

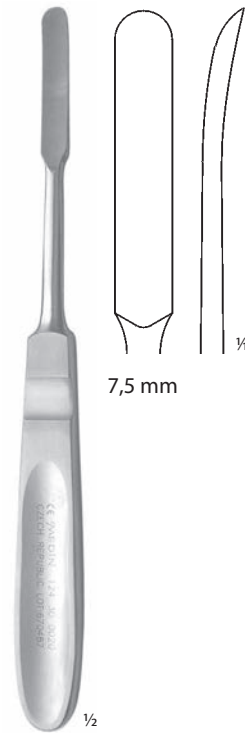

PŘECEHTĚL
124 30 0020
19,0 cm

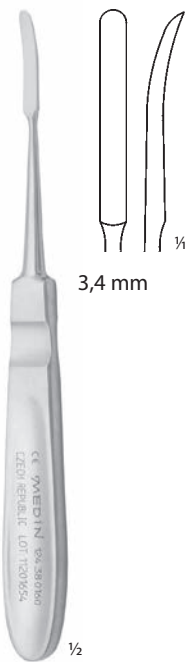

124 38 0160
17,2 cm

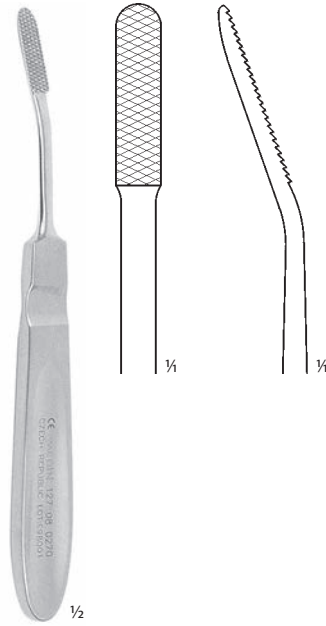

127 08 0270
15,9 cm

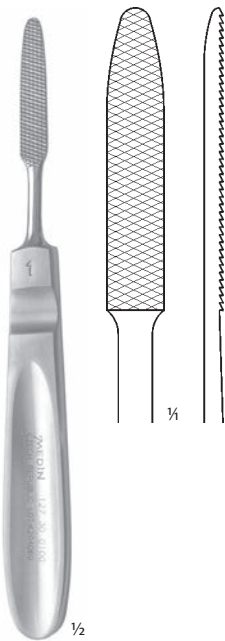

JOSEPH
127 30 0100
16,5 cm
Fig. 1

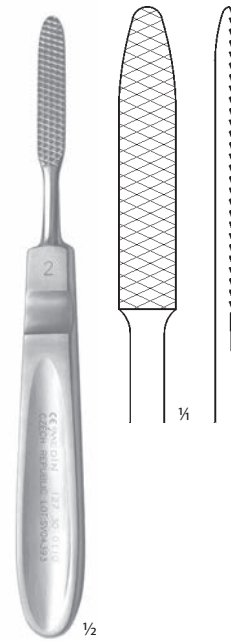

JOSEPH
127 30 0110
16,5 cm
Fig. 2

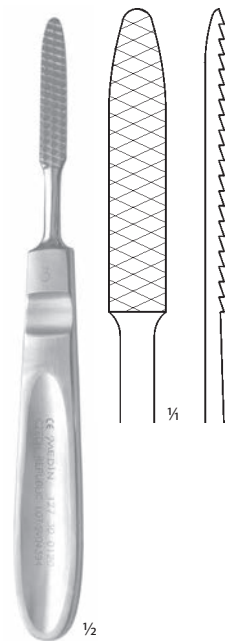

JOSEPH
127 30 0120
16,5 cm
Fig. 3

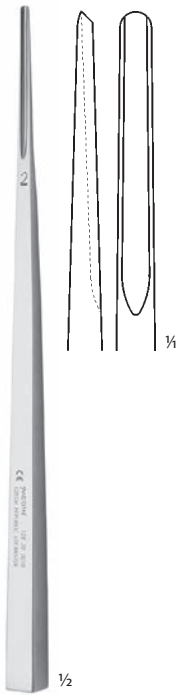

128 30 0010
18,0 cm
2 mm

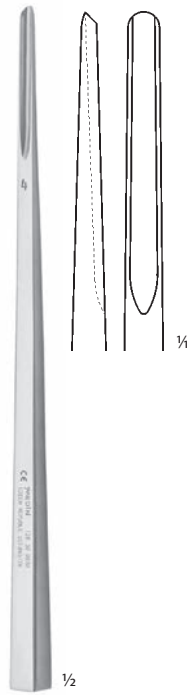

128 30 0030
18,0 cm
4 mm

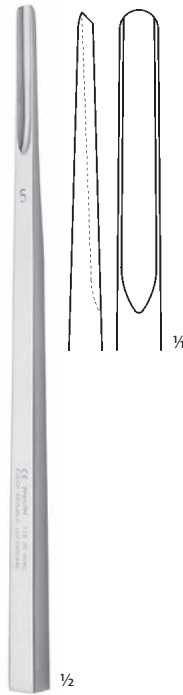

128 30 0040
18,0 cm
5 mm

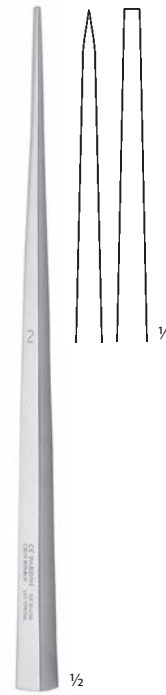

WEST
128 30 0200
18,0 cm
2 mm

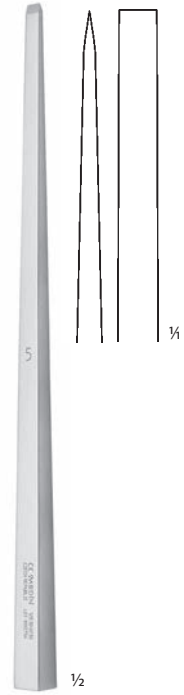

WEST
128 30 0230
18,0 cm
5 mm



Kladívko chirurgické
Surgical mallet
128 08 0901
250 g
22,3 cm



Kladívko chirurgické
Surgical mallet
128 08 0911
500 g
23,5 cm

HÁKY JEMNÉ
DELICATE HOOKS



118 91 0027
16,0 cm



118 08 0010



118 08 0050



118 08 0020



118 08 0060



118 91 0027



118 91 0035



118 91 0028
ostrý
sharp



118 91 0036
tupý
blunt



118 91 0046
ohobný
flexible
16,0 cm



118 91 0045



118 91 0048



118 91 0046



118 91 0049

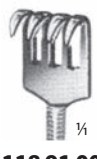

118 91 0047
ostrý
sharp



118 91 0050
tupý
blunt



JOSEPH
118 91 0051
16,0 cm



JOSEPH
118 91 0052
16,0 cm



118 91 0052
2,0 mm



118 91 0053
5,0 mm



118 91 0054
7,0 mm



118 91 0055
10,0 mm



DESMARRES
13,0 cm



MINI-LANGENBECK
16,0 cm



CUSHING
20,0 cm

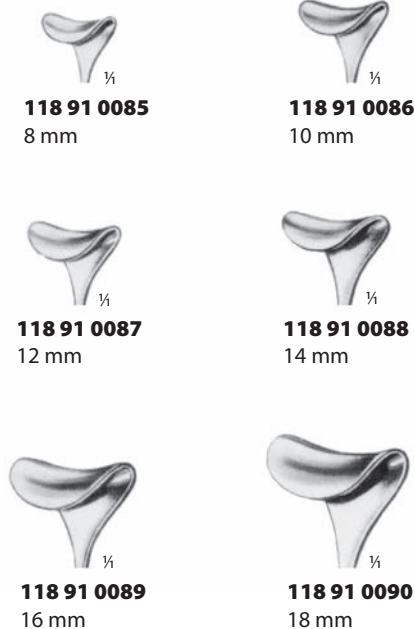

CUSHING
24,0 cm

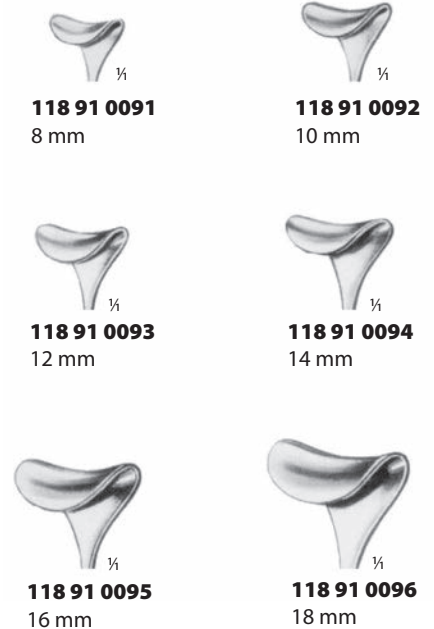

HÁKY JEMNÉ
DELICATE HOOKS

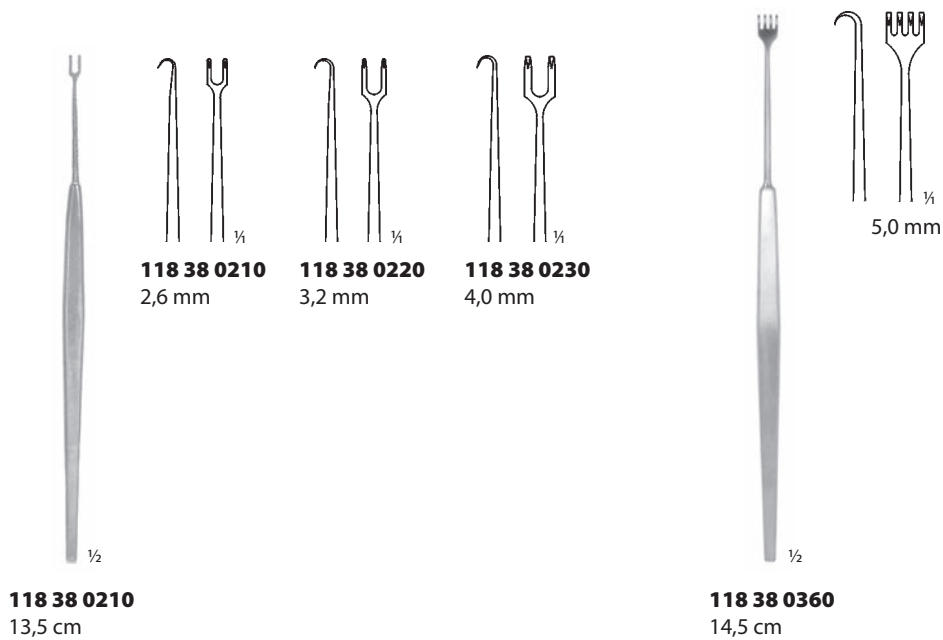
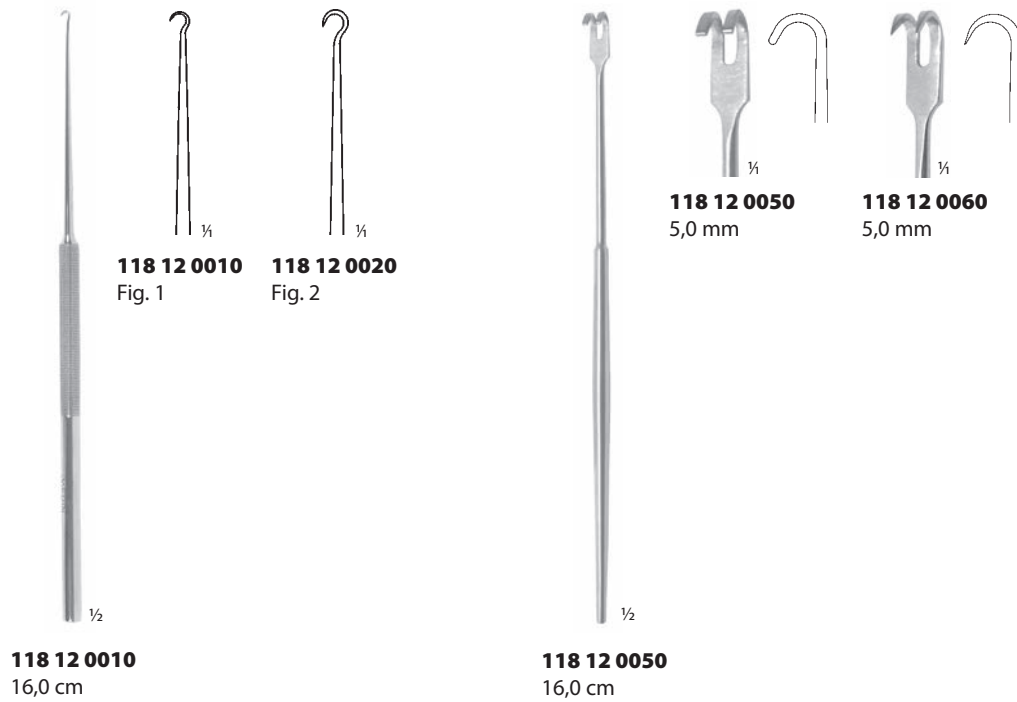



MIDDELDORPF
118 08 0650



118 08 0650
14 × 12 mm
22,0 cm



118 08 0660
21 × 21 mm
22,0 cm



118 08 0670
32 × 31 mm
23,5 cm



118 08 0680
62 × 50 mm
28,0 cm



MIDDELDORPF
118 91 0208



118 91 0208
14 × 17 mm
21,5 cm



118 91 0209
20 × 22 mm
22,0 cm

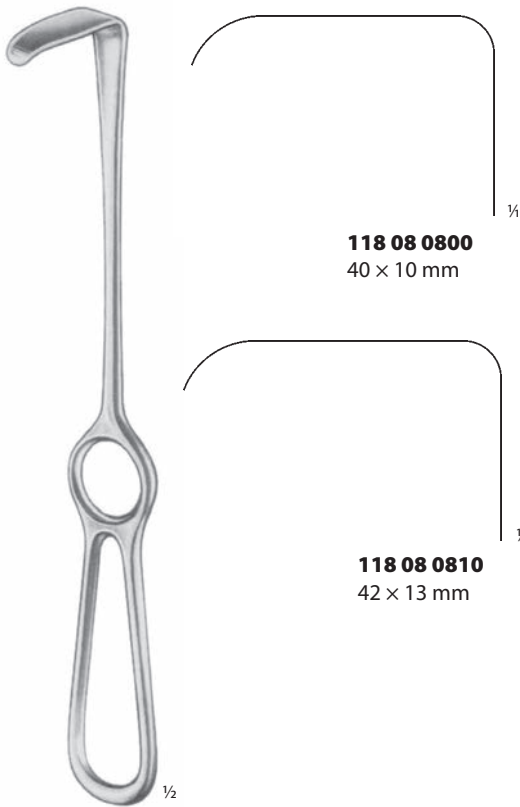

118 91 0210
26 × 30 mm
23,5 cm

HÁKY NA RÁNY
RETRACTORS

LANGENBECK
21,0 cm



ROUX
118 91 0294
sada (Fig. 1+2+3)
set (Fig. 1+2+3)
16,5 cm



118 91 0295
Fig. 1



118 91 0296
Fig. 2

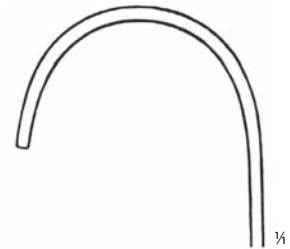

118 91 0297
Fig. 3

HÁKY RESEKČNÍ
RESECTION HOOKS

118 31 0040
rovný
straight
16,4 cm

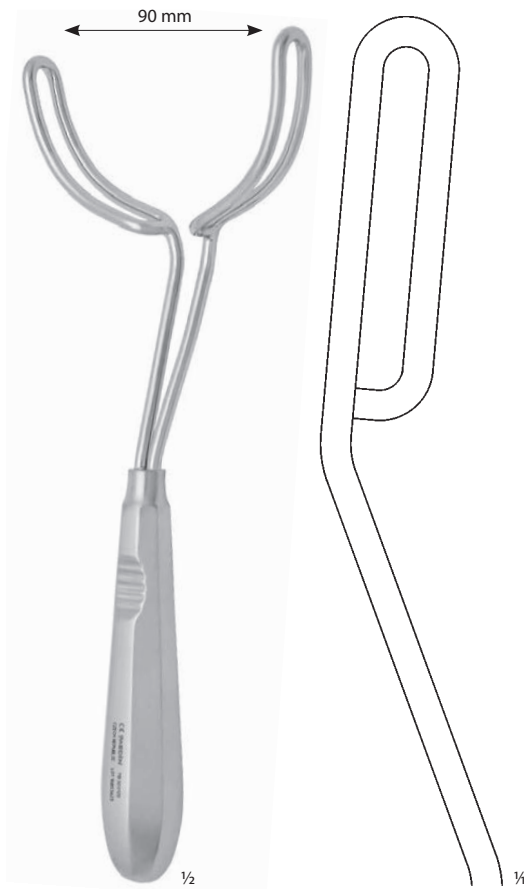

118 50 0120
22,9 cm

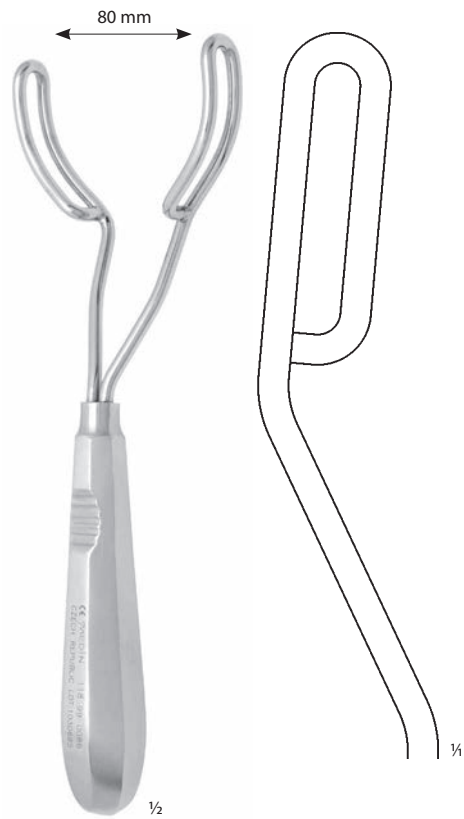

118 99 0086
20,8 cm

CHRÁNIČE PRSTU
FINGER PROTECTORS



LANGENBECK

	Ø
136 91 0001	2,20 cm
136 91 0002	2,45 cm
136 91 0003	2,65 cm

ROZVĚRAČE ÚST
MOUTH RETRACTORS

ROSER-KÖNIG
119 07 0010
19,5 cm

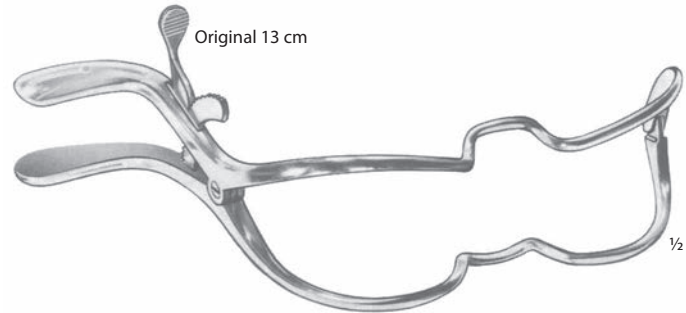

JENNINGS
119 91 0185 9,0 cm
119 91 0186 11,0 cm
119 91 0187 13,0 cm
119 91 0188 15,0 cm

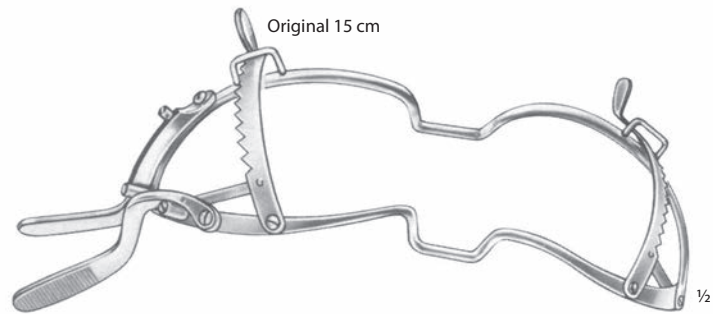

WHITEHEAD
119 91 0190 11,0 cm
119 91 0191 13,0 cm
119 91 0192 15,0 cm



HEISTER
119 07 0020
13,0 cm

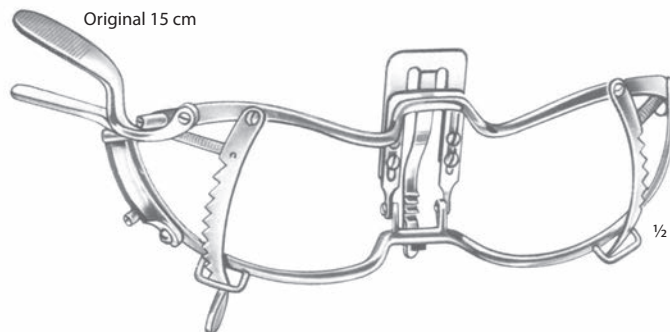

WHITEHEAD
119 91 0194 11,0 cm
119 91 0195 13,0 cm
119 91 0196 15,0 cm



● **125 50 0010**
rovná
straight
17,0 cm



● **125 50 0050**
lomená, ostrá
angled, sharp
17,0 cm

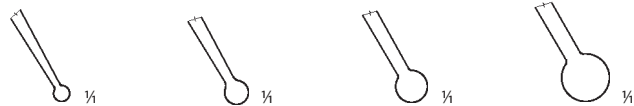
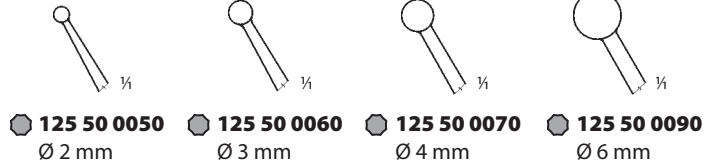

○ **125 56 0066**
lomená, ostrá
angled, sharp
16,7 cm



● **125 51 0156**
ostrá
sharp
16,6 cm



○ **125 56 0156**
ostrá
sharp
16,6 cm

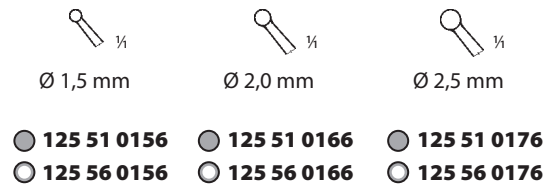

● **125 51 0156** ● **125 51 0166** ● **125 51 0176**
○ **125 56 0156** ○ **125 56 0166** ○ **125 56 0176**



LŽIČKY OSTRÉ
SHARP SPOONS



Original 17,0 cm



125 08 0110
17,0 cm
Fig. 000
3,5 mm



125 08 0120
17,2 cm
Fig. 0
4,8 mm



125 08 0130
17,5 cm
Fig. 1
6,0 mm



125 08 0140
17,7 cm
Fig. 3
8,5 mm



125 08 0150
18,4 cm
Fig. 5
12,0 mm



Original 17,5 cm



125 08 0160
16,5 cm
Fig. 1
3,0 mm



125 08 0170
16,5 cm
Fig. 2
3,5 mm



125 08 0180
17,5 cm
Fig. 3
4,0 mm



125 08 0190
17,5 cm
Fig. 4
5,0 mm



125 08 0200
19,5 cm
Fig. 5
6,0 mm



125 08 0210
19,5 cm
Fig. 6
6,7 mm

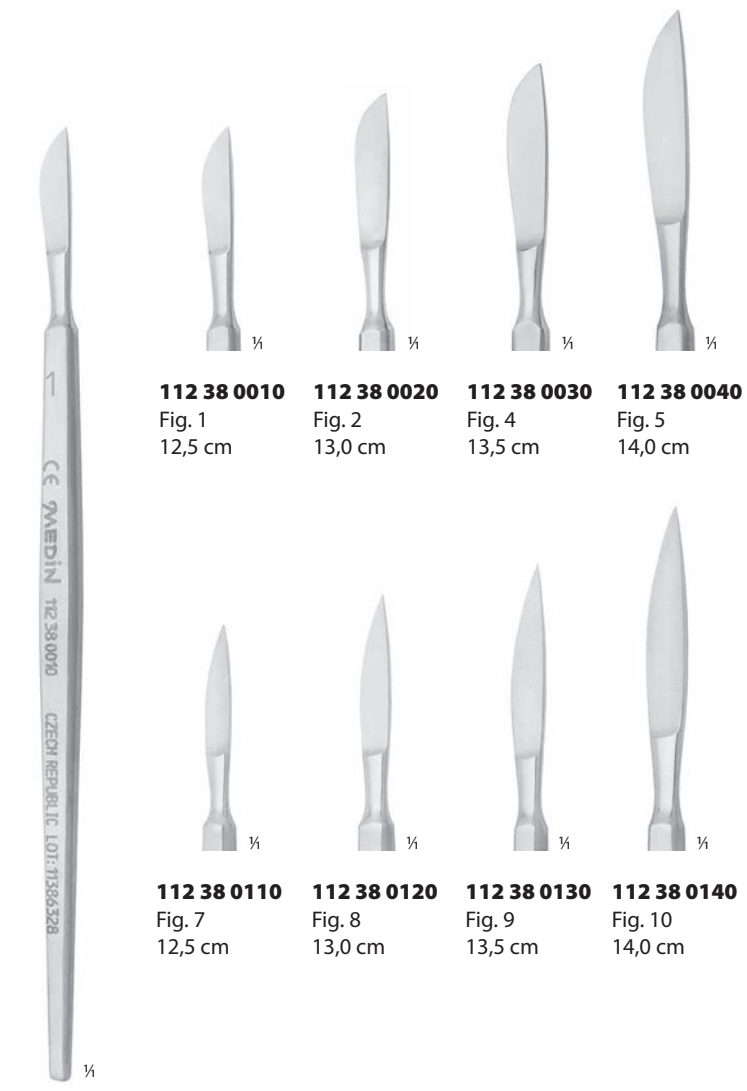

112 38 0010
Fig. 1
12,5 cm

112 38 0020
Fig. 2
13,0 cm

112 38 0030
Fig. 4
13,5 cm

112 38 0040
Fig. 5
14,0 cm

112 38 0110
Fig. 7
12,5 cm

112 38 0120
Fig. 8
13,0 cm

112 38 0130
Fig. 9
13,5 cm

112 38 0140
Fig. 10
14,0 cm

DIEFFENBACH
12,5 cm



112 91 0002
12,3 cm
Fig. 3



112 91 0003
12,3 cm
Fig. 3



112 91 0004
13,3 cm
Fig. 4



112 91 0005
20,5 cm
Fig. 3L

SKALPELOVÉ ČEPELKY STERILNÍ PRO VELIKOST DRŽÁTKA 3
SCALPEL BLADES STERILE FOR HANDLE SIZE 3

pro držátka
for handles

112 91 0002
112 91 0003
112 91 0005
112 91 0007
112 91 0008



112 91 0010
Fig. 10



112 91 0011
Fig. 11



112 91 0012
Fig. 12



112 91 0025
Fig. 12d



112 91 0013
Fig. 13



112 91 0015
Fig. 15



112 91 0026
Fig. 15c

POZNÁMKY: sterilní, balení 100 ks
NOTES: sterile, packing 100 pcs

SKALPELOVÉ ČEPELKY STERILNÍ PRO VELIKOST DRŽÁTKA 4
SCALPEL BLADES STERILE FOR HANDLE SIZE 4

pro držátka
for handles

112 91 0004
112 91 0006
112 08 0650



112 91 0018
Fig. 18



112 91 0020
Fig. 20



112 91 0021
Fig. 21



112 91 0022
Fig. 22



112 91 0023
Fig. 23



112 91 0024
Fig. 24



112 91 0027
Fig. 25

POZNÁMKY: sterilní, balení 100 ks
NOTES: sterile, packing 100 pcs

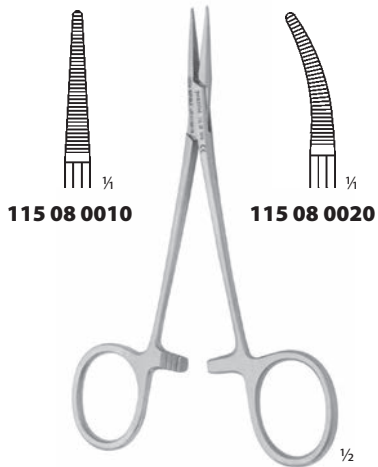
SVORKY NA CÉVY
ARTERY FORCEPS**MOSQUITO-HALSTED**

standard
standard
12,0 cm

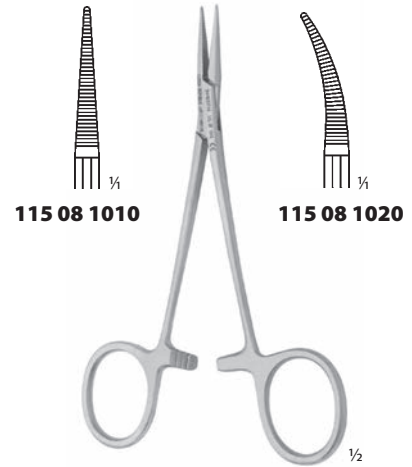
**MOSQUITO-HALSTED**

jemné
fine
12,0 cm

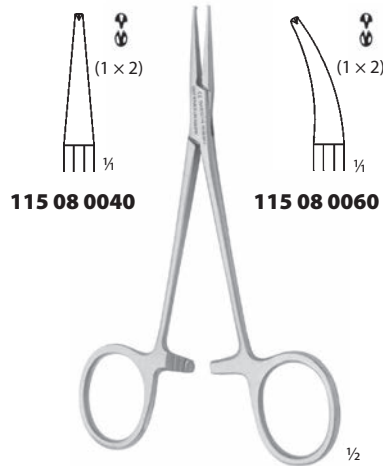
**MOSQUITO-HALSTED**

hladká čelist
smooth jaw
12,0 cm

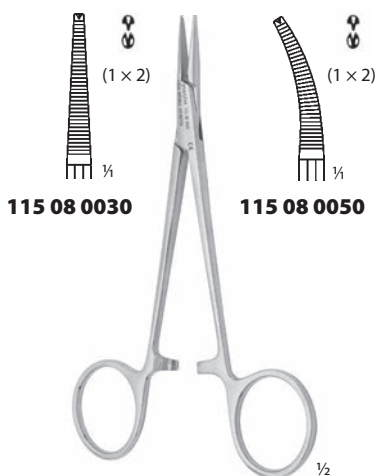
**MOSQUITO-HALSTEAD**

standard
standard
12,0 cm

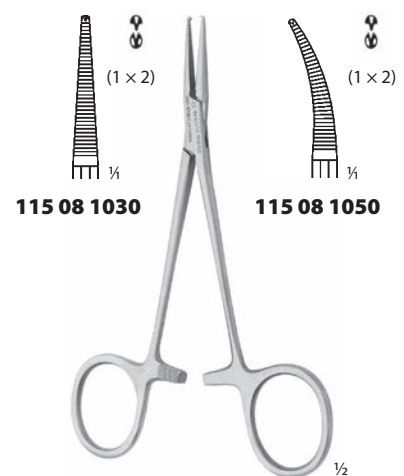
**MOSQUITO-HALSTEAD**

jemné
fine
12,0 cm

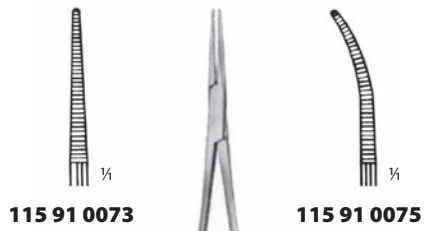

MICRO-MOSQUITO
12,0 cm

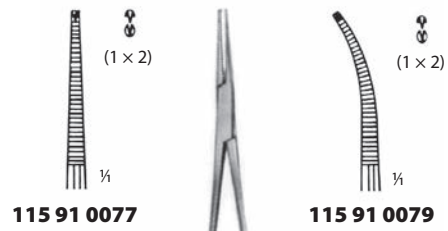

MICRO-MOSQUITO
12,0 cm

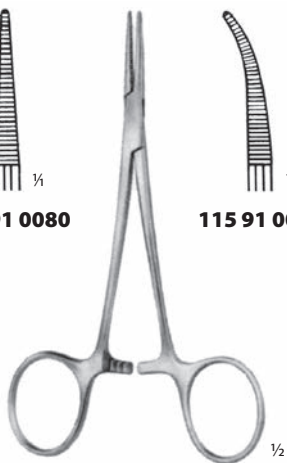
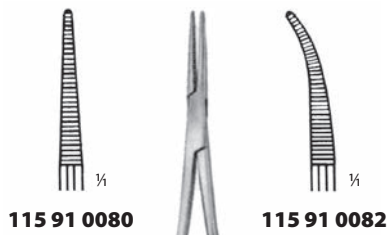

HALSTEAD-MOSQUITO
12,5 cm

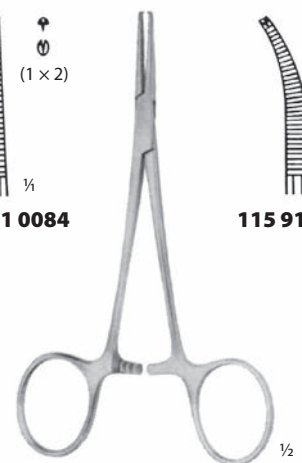
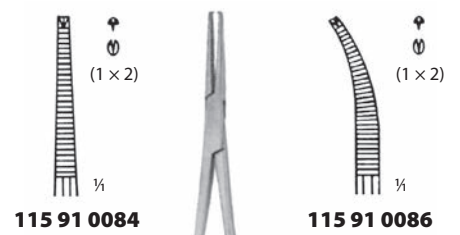

HALSTEAD-MOSQUITO
12,5 cm

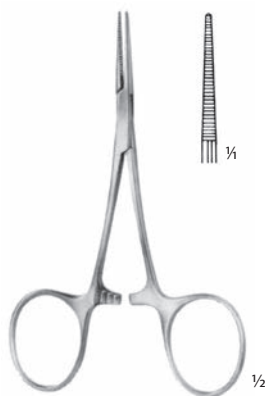

HARTMANN
115 91 0068
10,0 cm

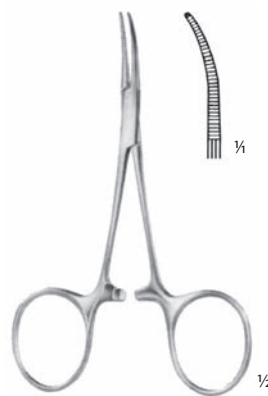

HARTMANN
115 91 0069
10,0 cm



BABCOCK
115 91 0382
16,0 cm



DE BAKEY

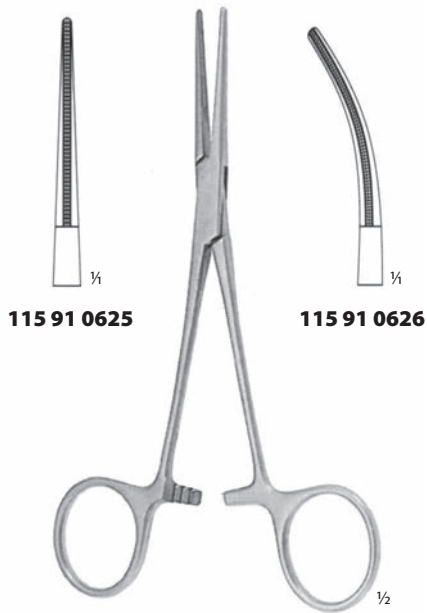

DE BAKEY-RANKIN
16,0 cm

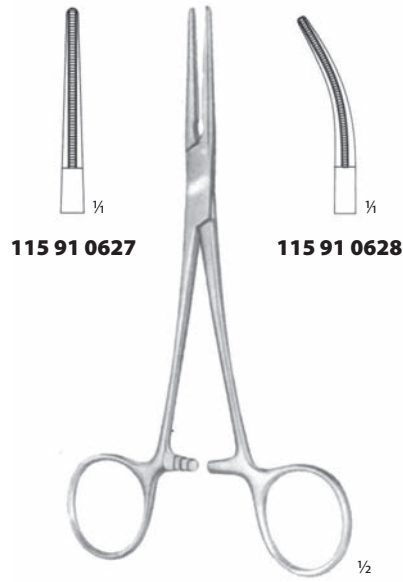

DE BAKEY-MOSQUITO
15,0 cm



DE BAKEY-MOSQUITO
12,0 cm

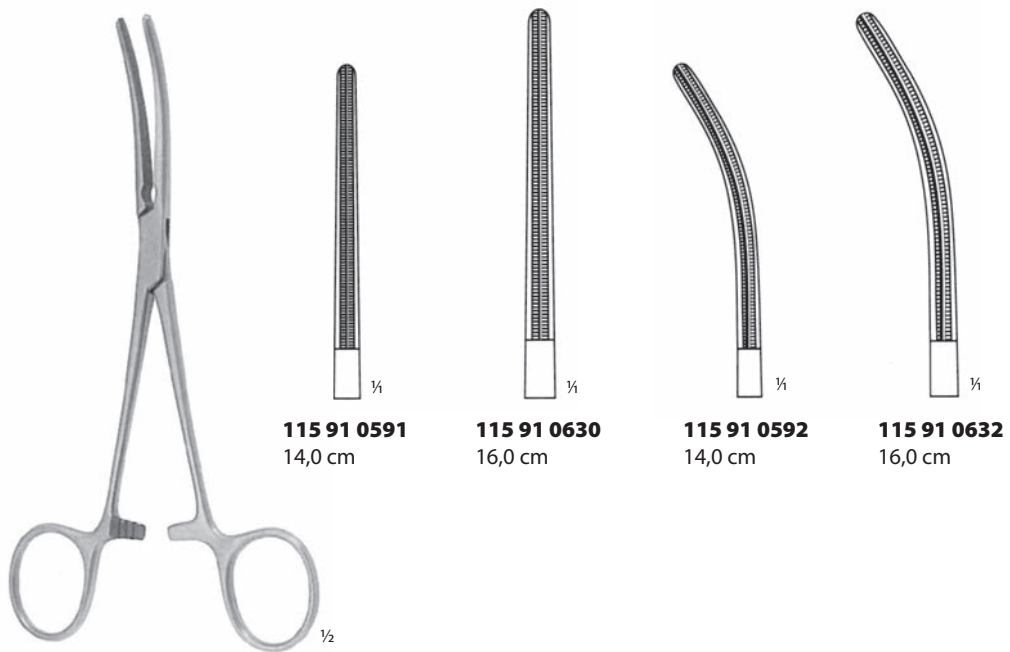

DE BAKEY-PEAN

115 91 0591
14,0 cm

115 91 0630
16,0 cm

115 91 0592
14,0 cm

115 91 0632
16,0 cm



BACKHAUS
115 08 0780
11,8 cm



BACKHAUS
115 08 0790
12,0 cm



BACKHAUS-CLIP
115 91 0341
11,0 cm



BACKHAUS
115 91 0343 11,0 cm
115 91 0345 15,0 cm



BACKHAUS
115 08 0810 8,0 cm
115 08 0820 13,0 cm



ROEDER
115 91 0348 13,0 cm
115 91 0349 15,0 cm

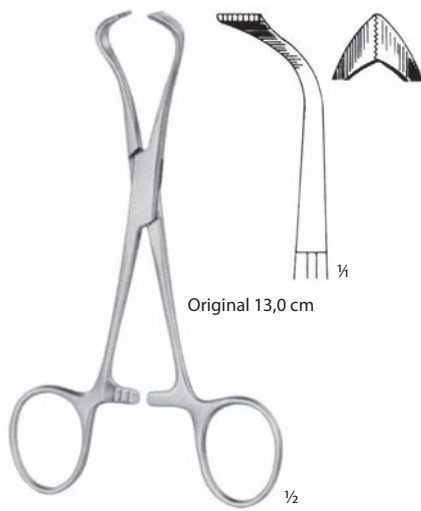

LORNA
115 91 0350 10,0 cm
115 91 0351 13,0 cm

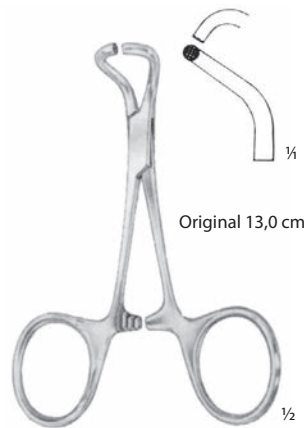

TOHOKU-JAPAN
115 91 0352 10,0 cm
115 91 0353 13,0 cm

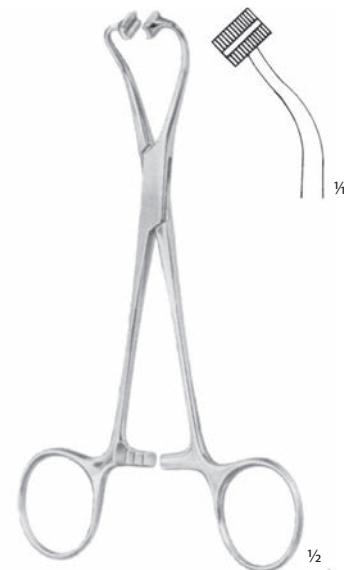

PEERS
115 91 0354
 14,5 cm

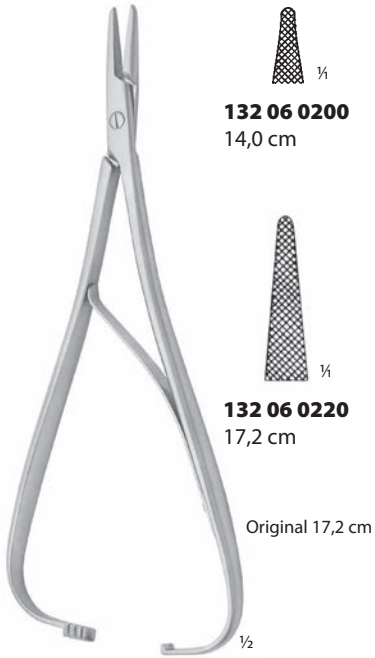

132 06 0200
14,0 cm

132 06 0220
17,2 cm

Original 17,2 cm

MATHIEU

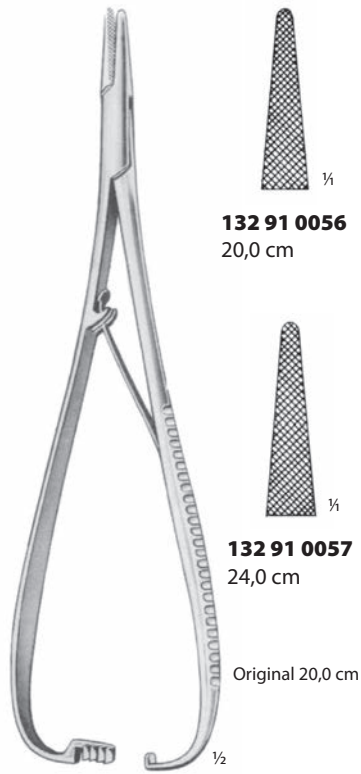

132 91 0056
20,0 cm

132 91 0057
24,0 cm

Original 20,0 cm

MATHIEU



132 06 0300
15,0 cm

Original 15,0 cm

CRILE



132 06 0810
20,5 cm



132 06 0341
16,5 cm



BOYNTON
132 38 0120
12,5 cm



Original 19,0 cm

OLSEN-HEGAR

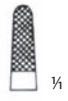

132 91 0160
14,0 cm

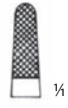

132 91 0161
17,0 cm



132 91 0162
19,0 cm



132 06 0610
16,5 cm



Original 25,5 cm

RYDER/FRENCH-EYE
132 06 0650
25,5 cm



132 06 0600
16,5 cm



132 06 0640
20,5 cm



132 06 0650
25,5 cm



MATHIEU
132 06 0520
14,0 cm



MATHIEU
132 06 0500
17,2 cm



MATHIEU
132 06 0510
21,5 cm



132 91 0168
17,0 cm

132 91 0169
20,0 cm

132 91 0170
23,0 cm



BOYNTON
132 91 0182
12,0 cm



CRILE
132 06 0370
15,7 cm



CRILE
132 06 0450
16,2 cm

JEHELCE TVRDOKOVOVÉ
NEEDLE HOLDERS WITH TUNGSTEN CARBIDE INSERT

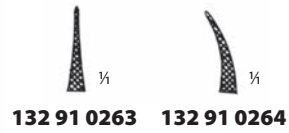
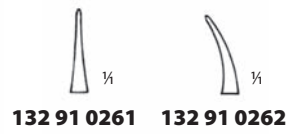

CASTROVIEJO
14,0 cm

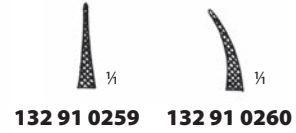
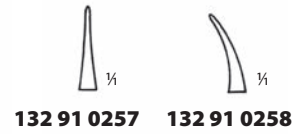

CASTROVIEJO
14,0 cm

MIKRO JEHELCE TVRDOKOVOVÉ
MICRO-NEEDLE HOLDERS WITH TUNGSTEN CARBIDE INSERT

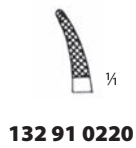
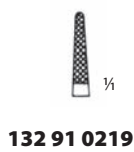

CASTROVIEJO
18,0 cm

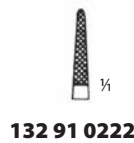

JACOBSON
21,0 cm

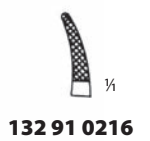
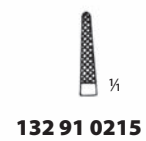

CASTROVIEJO
14,0 cm

ZAVADĚČE DRENŮ
DRAIN INTRODUCERS

LUNIATSCHEK
132 50 0180
17,0 cm



LUNIATSCHEK
132 50 0186
16,8 cm



LUNIATSCHEK
132 56 0186
16,8 cm



LUNIATSCHEK
132 50 0196
žlábkový
grooved
16,8 cm

○ osmihránné držátko – octagonal handle
 5,5 mm
 ○ plné držátko – round solid handle
 Ø 6,0 mm
 ○ duté držátko – hollow handle
 Ø 8,0 mm



LISTER
113 05 0030
15,0 cm



LISTER
113 05 0040
20,0 cm

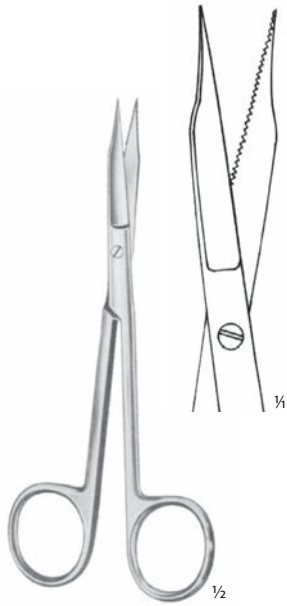

GOLDMANN-FOX
113 91 0474
se zuby, rovné
saw edge, straight
13,0 cm

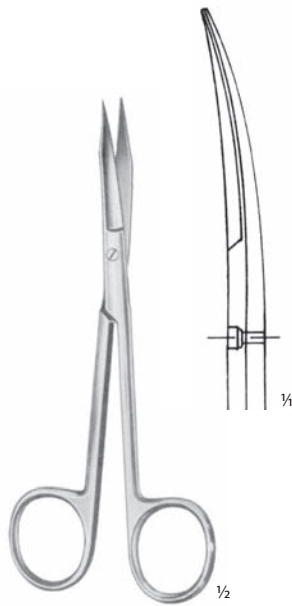

GOLDMANN-FOX
113 91 0475
se zuby, zahnuté
saw edge, curved
13,0 cm



QUINBY
113 91 0483
rovné
straight
12,0 cm

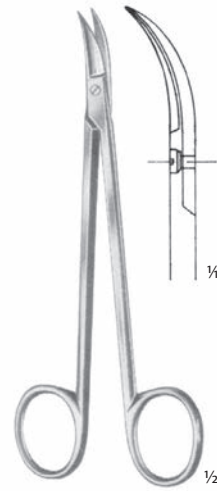

QUINBY
113 91 0484
zahnuté
curved
12,0 cm



113 50 0010
rovné
straight
12,0 cm

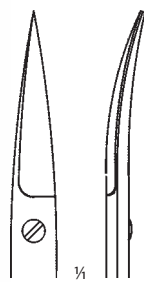

113 50 0020
zahnuté
curved
12,0 cm



113 50 0030
rovné
straight
14,5 cm

113 50 0040
zahnuté
curved
14,5 cm



SANVENERO
113 91 0221
rovné
straight
14,0 cm

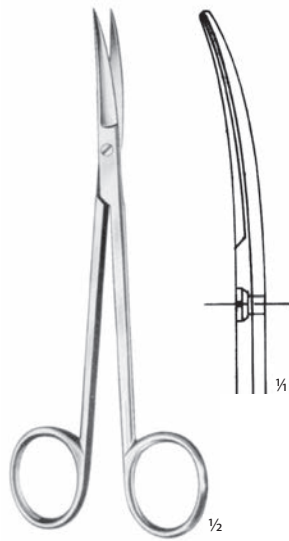

SANVENERO
113 91 0222
zahnuté
curved
14,0 cm



REYNOLDS
113 91 0233
rovné
straight
15,0 cm

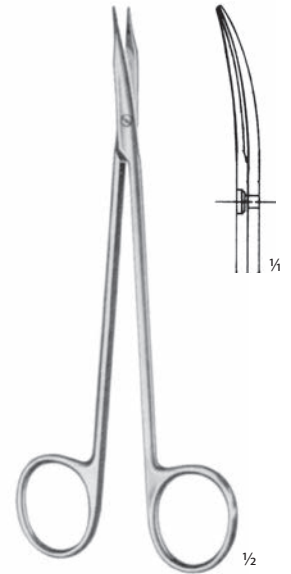

REYNOLDS
113 91 0235
zahnuté
curved
15,0 cm

NŮŽKY PRO LIGATURU
LIGATURE SCISSORS



SPENCER
113 91 0399 **113 91 0400**
9,0 cm 10,5 cm



LITTAUER
113 91 0403
14,0 cm

NŮŽKY CHIRURGICKÉ
OPERATING SCISSORS

Original 15 cm

STANDARD
hrotnaté rovné
sharp straight

113 08 0010 13,0 cm
113 08 0020 15,0 cm
113 08 0040 18,5 cm
113 08 0060 22,0 cm
113 08 0070 30,0 cm



Original 15 cm

STANDARD
hrotnaté zahnuté
sharp curved

113 08 0310 13,0 cm
113 08 0320 15,0 cm
113 08 0340 18,5 cm
113 08 0360 22,0 cm
113 08 0370 30,0 cm



Original 15 cm

STANDARD
hrotnatotupé rovné
sharp-blunt straight

113 08 0110 13,0 cm
113 08 0120 15,0 cm
113 08 0140 18,5 cm
113 08 0160 22,0 cm



Original 15 cm

STANDARD
hrotnatotupé zahnuté
sharp-blunt curved

113 08 0410 13,0 cm
113 08 0420 15,0 cm
113 08 0440 18,5 cm
113 08 0460 22,0 cm



Original 15 cm

STANDARD
tupé rovné
blunt straight

113 08 0210 13,0 cm
113 08 0220 15,0 cm
113 08 0240 18,5 cm
113 08 0260 22,0 cm



Original 15 cm

STANDARD
tupé zahnuté
blunt curved

113 08 0510 13,0 cm
113 08 0520 15,0 cm
113 08 0540 18,5 cm
113 08 0560 22,0 cm



Original 16,5 cm

STANDARD
hrotnaté rovné
sharp straight

113 91 0042 11,5 cm
113 91 0046 16,5 cm
113 91 0049 20,0 cm



Original 16,5 cm

STANDARD
hrotnaté zahnuté
sharp curved

113 91 0051 11,5 cm
113 91 0055 16,5 cm
113 91 0058 20,0 cm



Original 16,5 cm

STANDARD
hrotnatotupé rovné
sharp-blunt straight

113 91 0020 11,5 cm
113 91 0026 16,5 cm
113 91 0029 20,0 cm



Original 16,5 cm

STANDARD
hrotnatotupé zahnuté
sharp-blunt curved

113 91 0031 11,5 cm
113 91 0037 16,5 cm
113 91 0040 20,0 cm



Original 16,5 cm

STANDARD
tupé rovné
blunt straight

113 91 0002 11,5 cm
113 91 0006 16,5 cm
113 91 0009 20,0 cm



Original 16,5 cm

STANDARD
tupé zahnuté
blunt curved

113 91 0011 11,5 cm
113 91 0015 16,5 cm
113 91 0018 20,0 cm



WAGNER
113 91 0328
jemné rovné
fine straight
12,0 cm



WAGNER
113 91 0331
jemné zahnuté
fine curved
12,0 cm

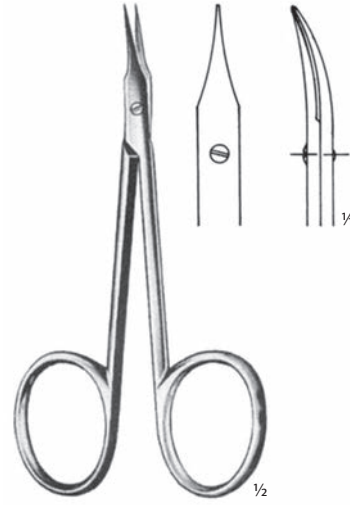

WALTON
113 91 0348
10,0 cm

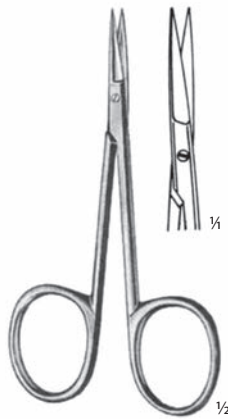

MOD. BONN
113 91 0349
extra jemné
extra delicate
8,0 cm

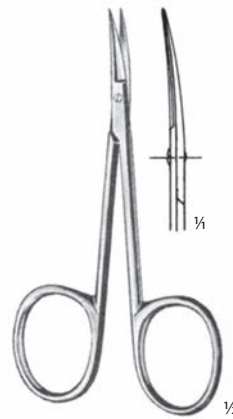

MOD. BONN
113 91 0350
extra jemné
extra delicate
8,0 cm



10,0 cm
11,5 cm

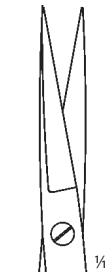

113 38 0010
113 38 0071
hrotnaté rovné
sharp straight

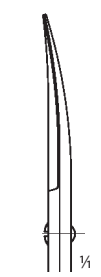

113 38 0040
113 38 0091
hrotnaté zahnuté
sharp curved

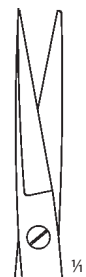

113 38 0020
113 38 0150
hrotnatotupé rovné
sharp-blunt straight



113 38 0050
113 38 0100
hrotnatotupé zahnuté
sharp-blunt curved

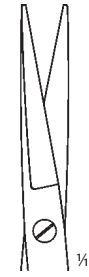

113 38 0030
113 38 0081
tupé rovné
blunt straight



113 38 0060
113 38 0161
tupé zahnuté
blunt curved



113 38 0210
hrotnaté
sharp
10,5 cm

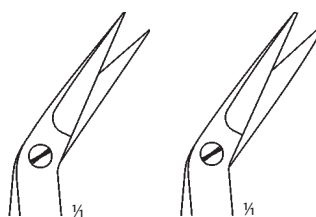

113 38 0260
tupé
blunt
10,5 cm



113 38 0311
11,5 cm

NŮŽKY OČNÍ
EYE SCISSORS



NOYES
12,0 cm



113 91 0490



113 91 0492



113 91 0494

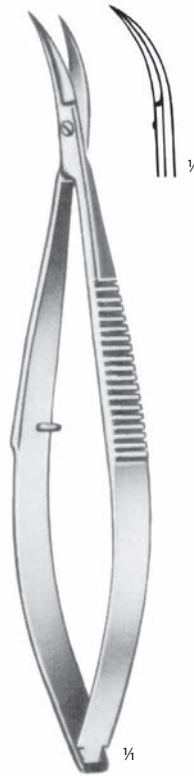

CASTROVIEJO
113 91 0507
10,0 cm



CASTROVIEJO
113 91 0508
10,0 cm



CASTROVIEJO
113 91 0502
9,0 cm



113 91 0503



113 38 1020



113 91 0505



113 38 1030

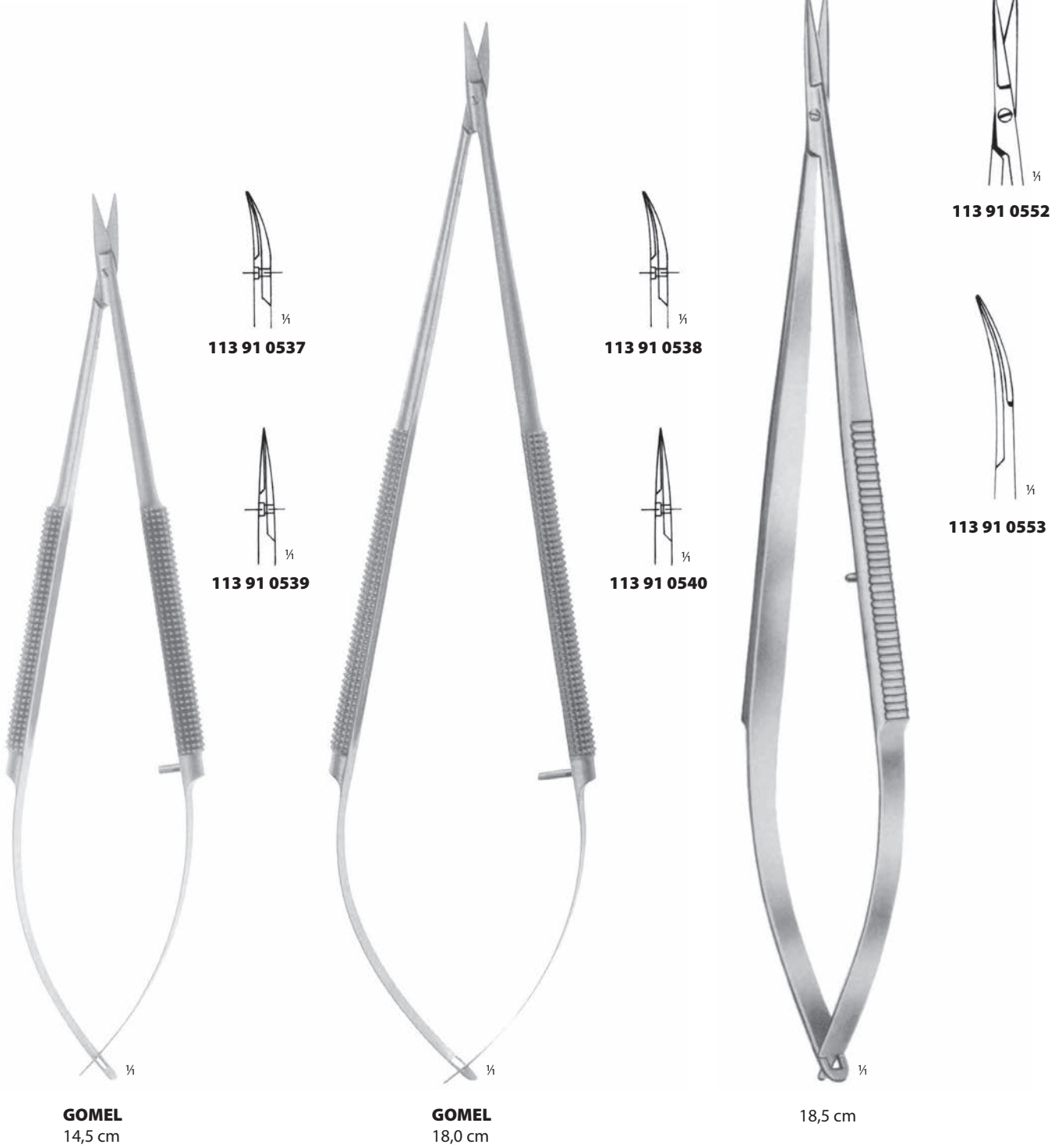

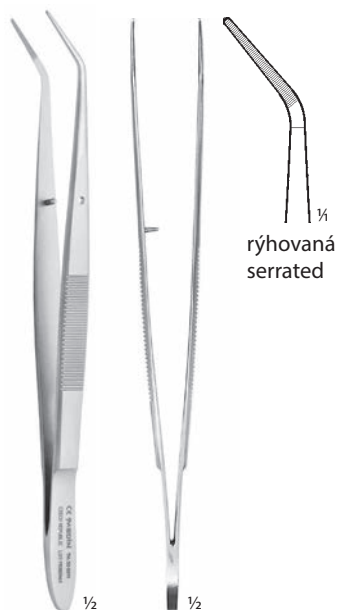

114 50 0011
zahnutá
curved
15,7 cm



114 50 0021
lomená
angled
15,7 cm



114 50 0031
lomená
angled
15,7 cm



114 50 1030
lomená
angled
15,7 cm



114 50 0051
15,7 cm



114 50 0150
zahnutá, jemná
curved, fine
14,2 cm



114 50 0170
zahnutá
curved
15,7 cm



114 08 0090
14,5 cm



114 08 0101
jemná
fine
14,5 cm



114 08 0231
velmi jemná
very fine
14,5 cm



114 08 0140
jemná
fine
20,0 cm



114 08 0240
velmi jemná
very fine
20,0 cm



114 08 0250
24,5 cm

PINZETY ANATOMICKÉ
DRESSING FORCEPS

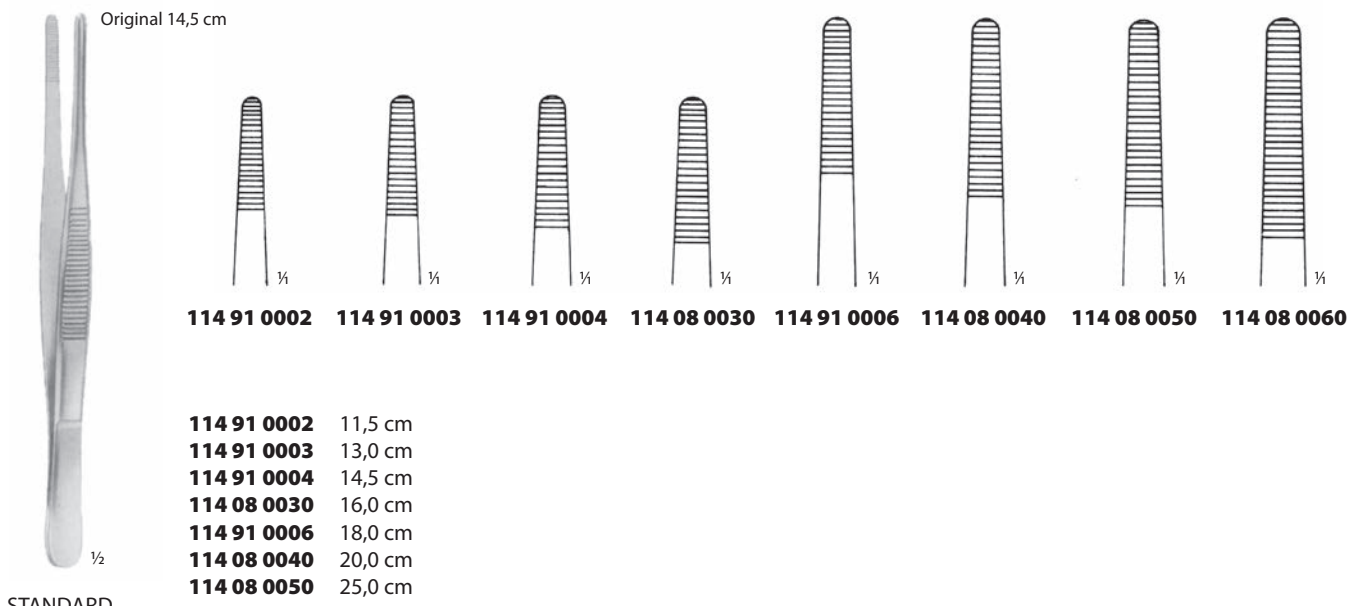

Original 14,5 cm

1/2

STANDARD

114 91 0002	114 91 0003	114 91 0004	114 08 0030	114 91 0006	114 08 0040	114 08 0050	114 08 0060
11,5 cm	13,0 cm	14,5 cm	16,0 cm	18,0 cm	20,0 cm	25,0 cm	30,0 cm

PINZETY CHIRURGICKÉ
TISSUE FORCEPS

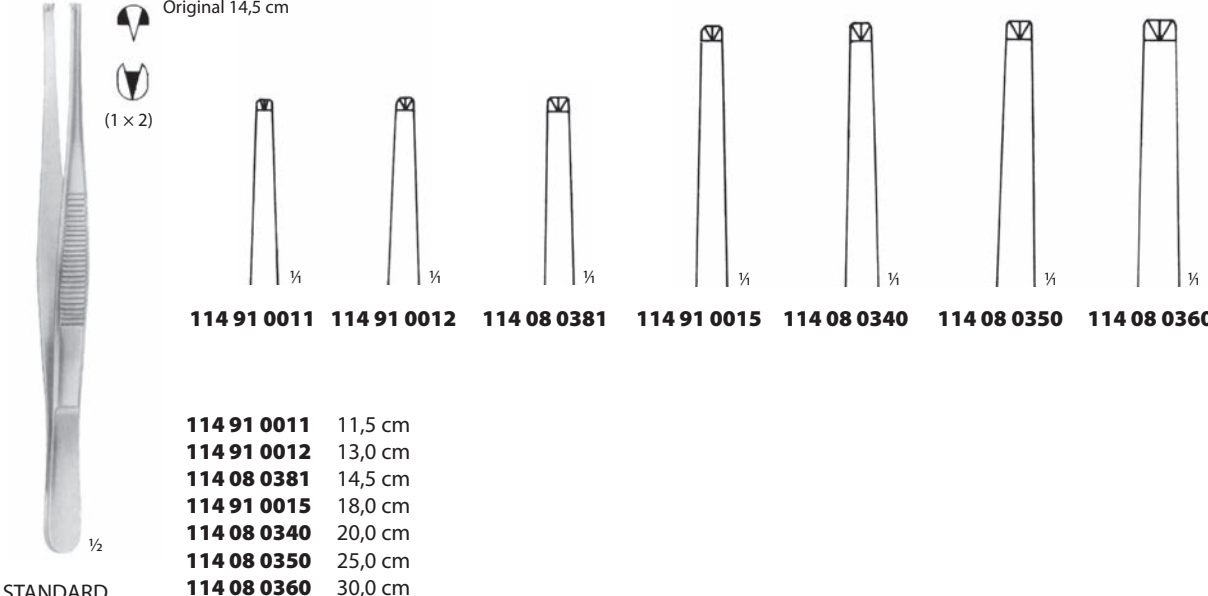

Original 14,5 cm

(1 x 2)

1/2

STANDARD

114 91 0011	114 91 0012	114 08 0381	114 91 0015	114 08 0340	114 08 0350	114 08 0360
11,5 cm	13,0 cm	14,5 cm	18,0 cm	20,0 cm	25,0 cm	30,0 cm

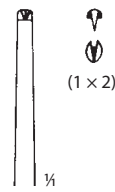

114 08 0430
jemná
fine
16,0 cm

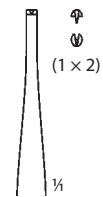

114 08 0530
velmi jemná
very fine
14,5 cm

PINZETY ŠÍČÍ
SUTURING FORCEPS



Original 12,0 cm



114 91 0255
12,0 cm



114 91 0257
12,0 cm

114 91 0256
15,0 cm

114 91 0258
15,0 cm

PINZETY TVRDOKOVOVÉ
FORCEPS WITH TUNGSTEN CARBIDE INSERT



(1 × 2)

114 91 0477 14,0 cm

114 91 0478 16,0 cm

114 91 0479 18,0 cm

Original 18,0 cm

114 91 0480 20,0 cm

114 91 0481 25,0 cm

114 91 0482 30,0 cm

1/2

OEHLER



Original 12,0 cm

(1 × 2)

114 91 0487 12,0 cm

114 91 0490 12,0 cm

114 91 0489 15,0 cm

114 91 0491 15,0 cm

1/2

ADSON



(2 × 1)

Original 12,5 cm

114 91 0483 12,5 cm

114 91 0484 15,5 cm

1/2

SEMKEN



(2 × 1)

114 91 0485 15,0 cm

1/2

GILLIES



(1 × 2)

114 91 0486 15,0 cm

1/2

JEWELER

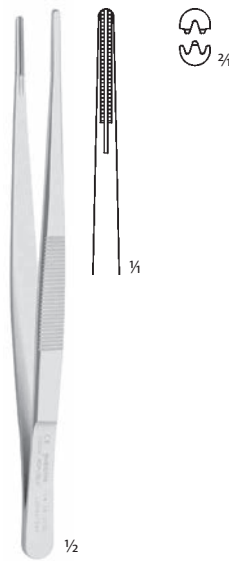

114 14 0100
14,5 cm

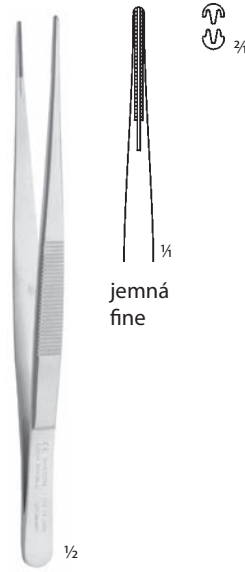

114 14 0300
14,5 cm

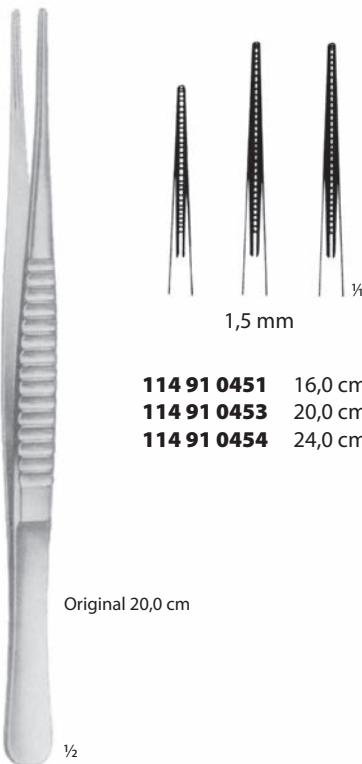

114 91 0451 16,0 cm
114 91 0453 20,0 cm
114 91 0454 24,0 cm

DE BAKEY

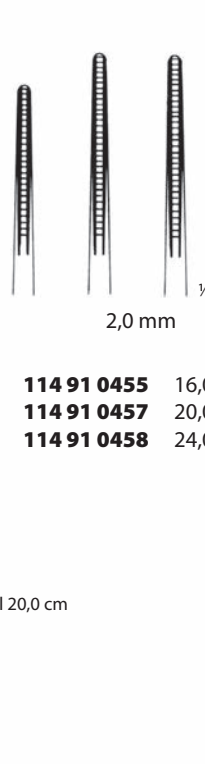

114 91 0455 16,0 cm
114 91 0457 20,0 cm
114 91 0458 24,0 cm

DE BAKEY

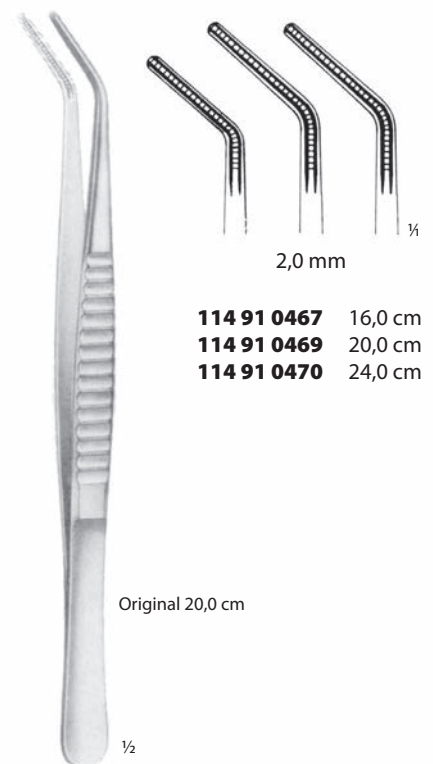

114 91 0467 16,0 cm
114 91 0469 20,0 cm
114 91 0470 24,0 cm

DE BAKEY



GRAEFE
10,5 cm



114 38 0010



114 38 0020
jemná
fine



114 38 0150

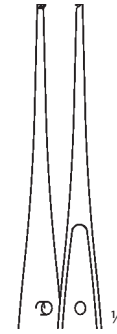

114 38 0160
jemná
fine

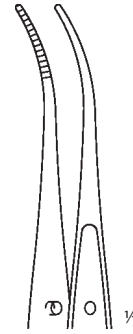

114 38 0100
jemná
fine



GRAEFE
114 38 0360
11,0 cm

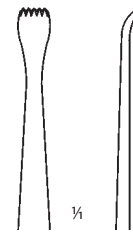

se zámkem
with lock

B

DIAGNOSTIKA
DIAGNOSTICS



Sondy, pátridla

Lopatky

Zrcátka

Probes

Spatulas

Mirrors

71

72

72–73

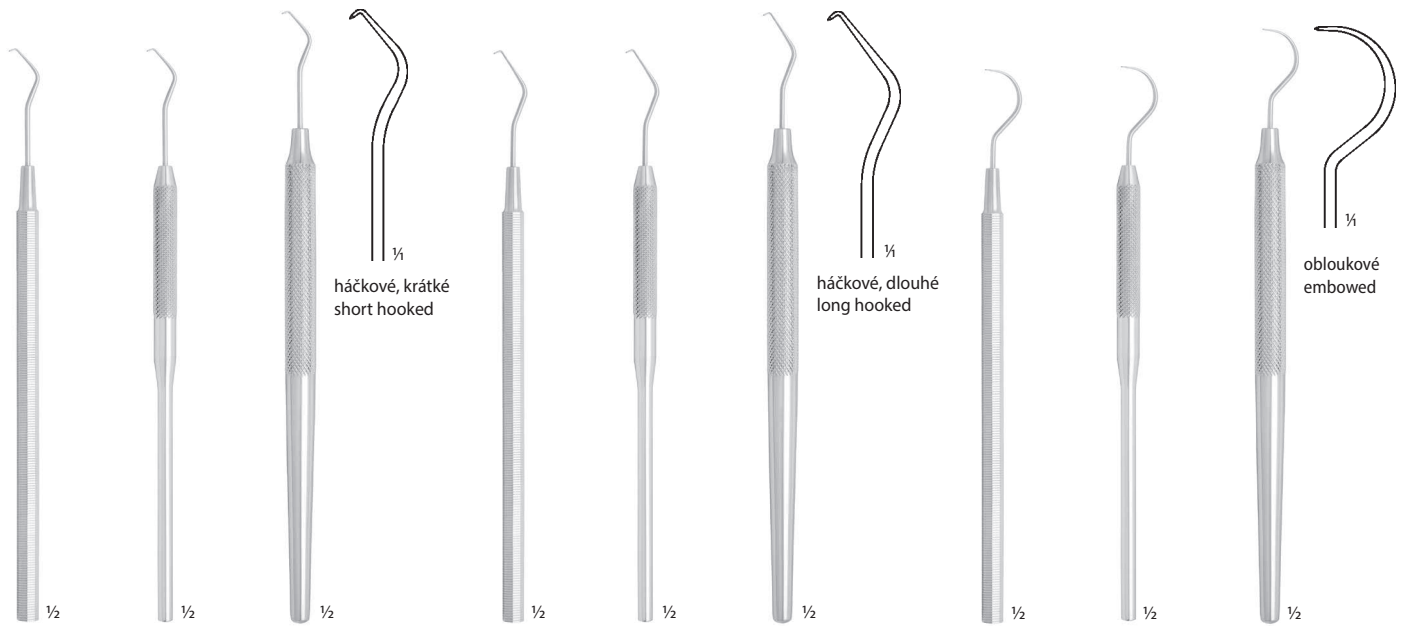

133 51 0010 15,2 cm	133 51 0016 15,2 cm	133 56 0016 16,3 cm	133 51 0020 15,1 cm	133 51 0026 15,1 cm	133 56 0026 16,2 cm	133 51 0030 14,5 cm	133 51 0036 14,5 cm	133 56 0036 15,6 cm
-------------------------------	-------------------------------	-------------------------------	-------------------------------	-------------------------------	-------------------------------	-------------------------------	-------------------------------	-------------------------------

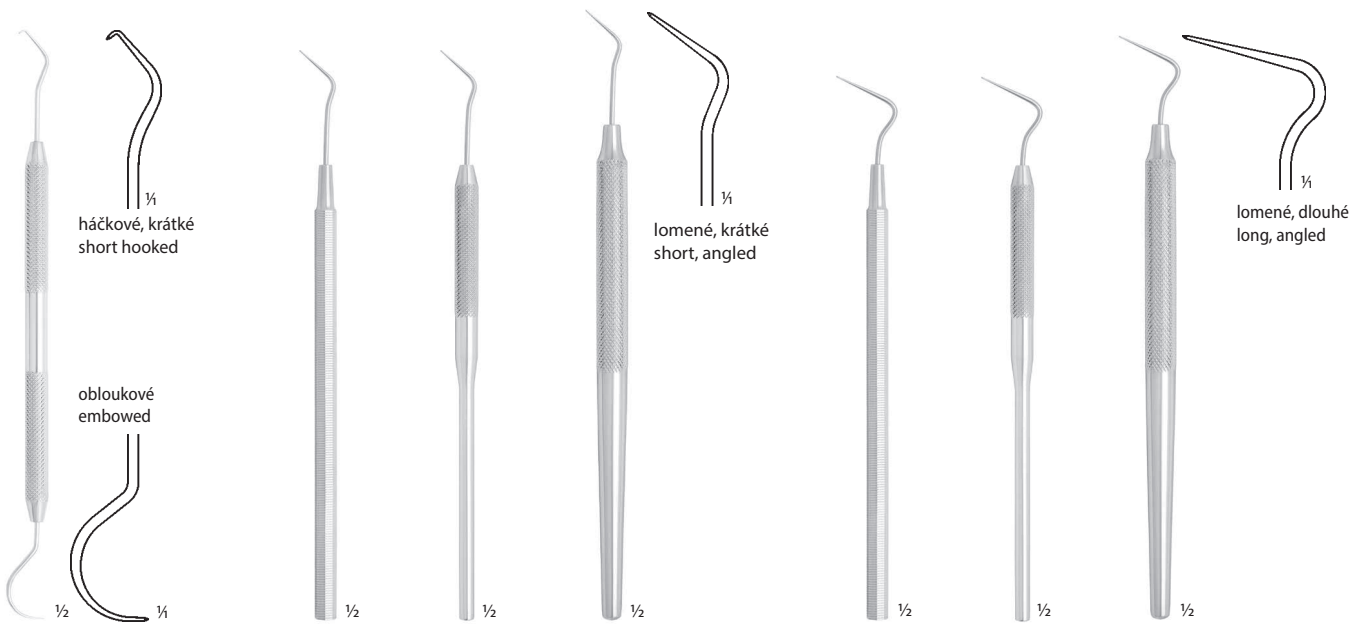

133 99 0186 15,7 cm	133 51 0040 15,0 cm	133 51 0046 15,0 cm	133 56 0046 16,1 cm	133 51 0050 14,0 cm	133 51 0056 14,0 cm	133 56 0056 15,1 cm
-------------------------------	-------------------------------	-------------------------------	-------------------------------	-------------------------------	-------------------------------	-------------------------------



BOWMANN
133 38 0060 Ø 0,5 mm 13,0 cm
133 38 0070 Ø 0,7 mm 13,0 cm
133 38 0080 Ø 0,9 mm 13,0 cm

LOPATKY
SPATULAS

BUCHWALD
121 31 0010
17,3 cm
16/23 mm



BRÜNNINGS
121 31 0020
19,5 cm
14/18 mm

ZRCÁTKA INTRAORÁLNÍ
INTRAORAL MIRRORS

HR FRONT
BUCCAL
122 91 0420

přední vrstva se zvýšenou odrazivostí,
jednostranné, síla 3 mm, šířka 4 cm
high reflection front coating
one-side coated, thickness 3 mm, bridth 4 cm
16,0 cm



HR FRONT
OCCUSAL
122 91 0421

přední vrstva se zvýšenou odrazivostí,
jednostranné, síla 3 mm, šířka 6,5/4 cm
high reflection front coating
one-side coated, thickness 3 mm, bridth 6,5/4 cm
15,0 cm



přední vrstva
front surface



122 51 0010
 1 : 1
 ploché
 plane
 Ø 24 mm



122 51 0020
 2,25×
 zvětšovací
 magnifying
 Ø 24 mm



HR FRONT
 přední vrstva se zvýšenou odrazivostí
 high reflection front coating
122 91 0411 1 : 1 Fig. 8 Ø 30 mm
122 91 0333 1 : 1 Fig. 5 Ø 24 mm
122 91 0407 1 : 1 Fig. 4 Ø 22 mm
122 91 0408 1 : 1 Fig. 0 Ø 14 mm



přední vrstva
 front surface

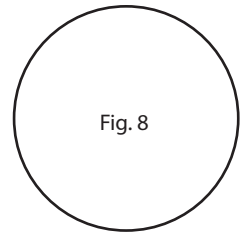

Fig. 8

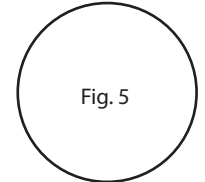

Fig. 5

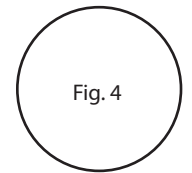

Fig. 4

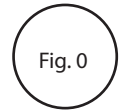

Fig. 0

POZNÁMKY: balení 12 ks
 NOTES: packing 12 pcs

DRŽÁTKA ZUBNÍCH ZRCÁTEK
DENTAL MIRROR HANDLES



● **122 51 0100**
 osmihranné držátko 5,5 mm
 octagonal handle 5,5 mm
 12,0 cm



● **122 51 0106**
 plné držátko Ø 6,0 mm
 round solid handle Ø 6,0 mm
 12,0 cm

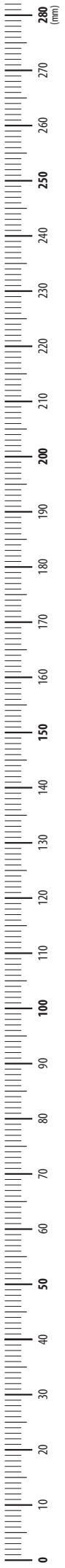

○ **122 56 0106**
 duté držátko Ø 8,0 mm
 hollow handle Ø 8,0 mm
 13,0 cm



A series of horizontal lines extending across the page, providing a template for writing or drawing. The lines are evenly spaced and correspond to the 10 mm intervals of the ruler on the left.



ZÁCHOVNÁ STOMATOLOGIE

RESTORATIVE



Exkavátory	Excavators	77–78
Nástroje pro výplně	Filling Instruments	79–92
Lopatky	Spatulas	93
Matrice	Matrixes	94–95
Nástroje na snímání korunek	Crown Removers	96

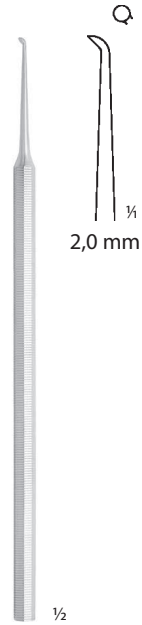

148 51 0010
rovný
straight
15,5 cm



148 51 0016
rovný
straight
15,5 cm



148 51 0056
pravý
right
15,5 cm

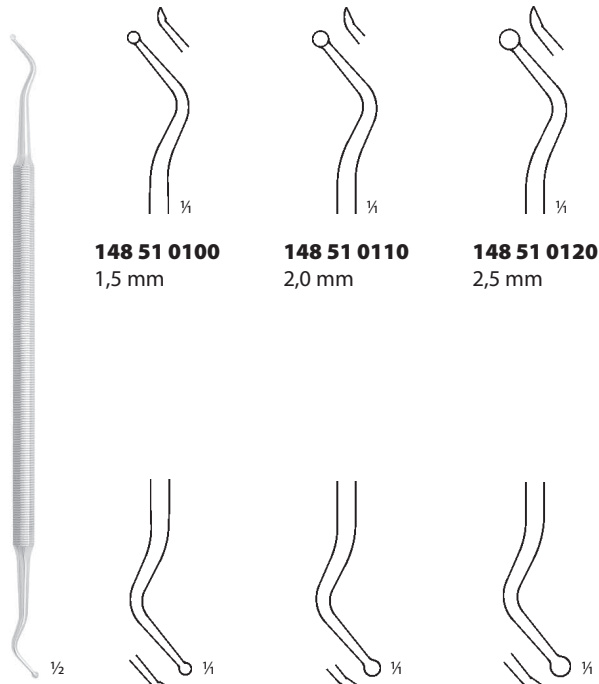
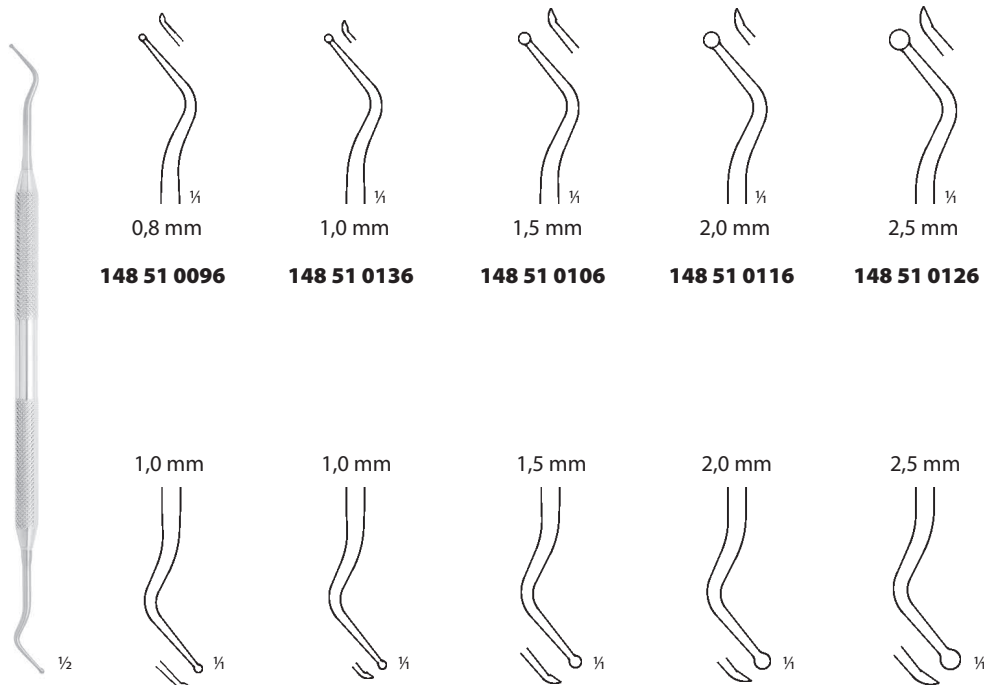

148 51 0076
levý
left
15,5 cm

EXKAVÁTORY
EXCAVATORS**148 51 0100**
1,5 mm**148 51 0110**
2,0 mm**148 51 0120**
2,5 mm**148 51 0100**
oboustranný
double faced
17,0 cm**148 51 0096**
0,8 mm**148 51 0136**
1,0 mm**148 51 0106**
1,5 mm**148 51 0116**
2,0 mm**148 51 0126**
2,5 mm**148 51 0106**
oboustranný
double faced
16,8 cm

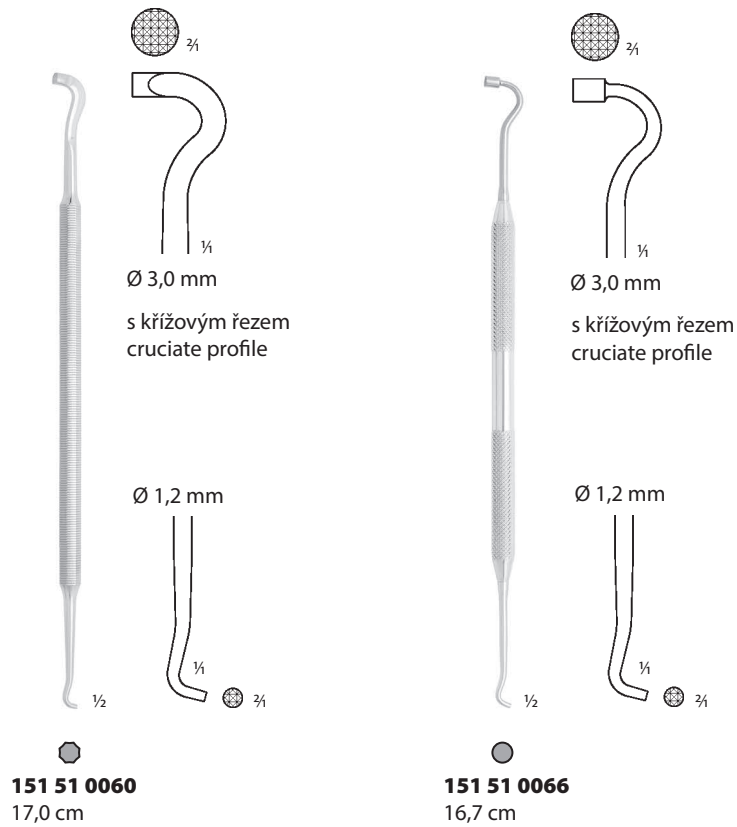
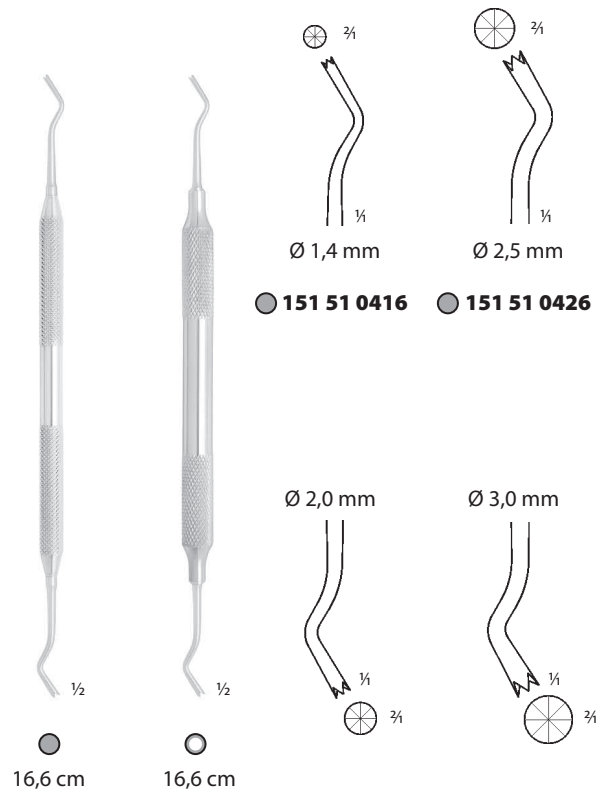

CPÁTKA
FILLING INSTRUMENTS

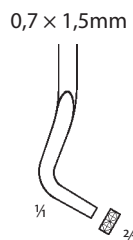
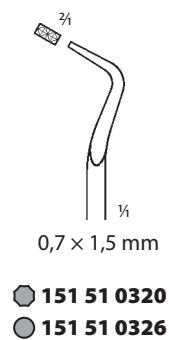
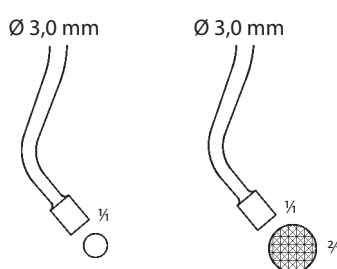
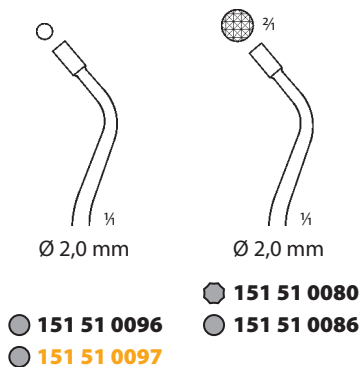

⬡	osmihranné držátko – octagonal handle	5,5 mm
●	plné držátko – round solid handle	Ø 6,0 mm
○	duté držátko – hollow handle	Ø 8,0 mm

151 5X XXXX	nerez – stainless steel
151 5X XXXX	TiN povlak – TiN surface



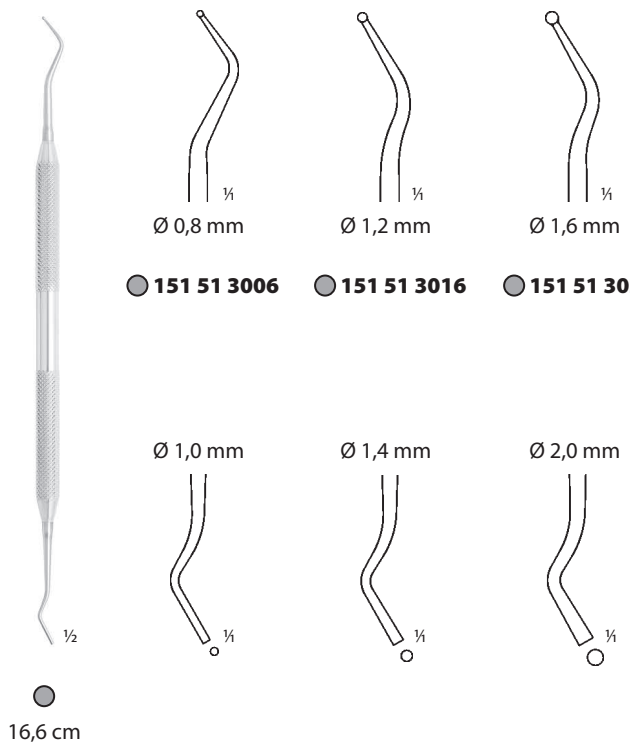
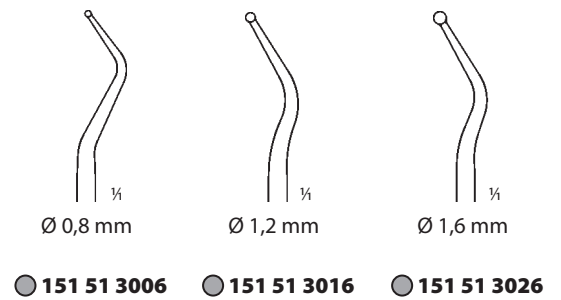
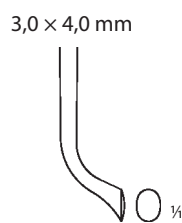
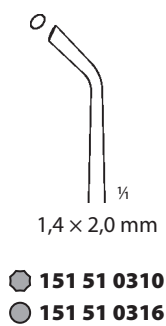
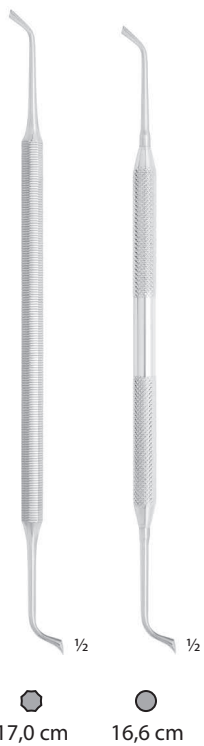
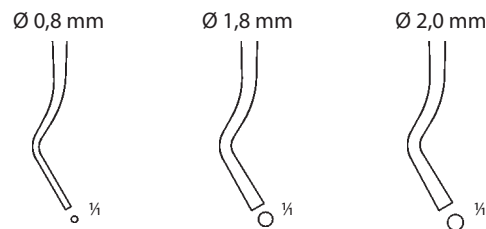
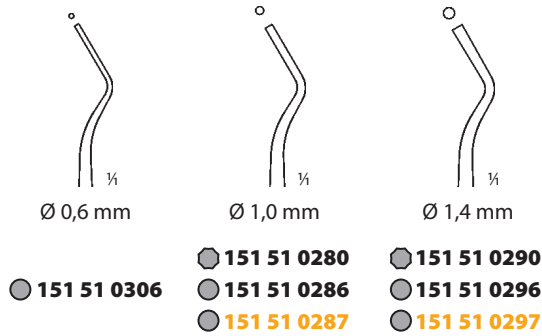
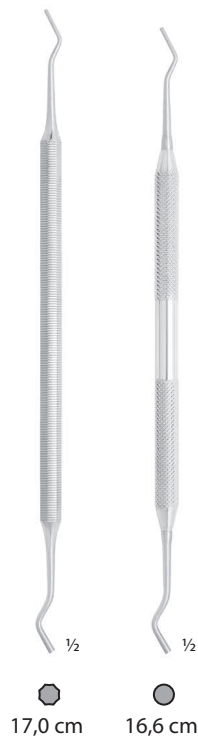

kopytkové – hoof profile

kombinované – combined

● osmihránné držátko – octagonal handle	5,5 mm
● plné držátko – round solid handle	Ø 6,0 mm
● duté držátko – hollow handle	Ø 8,0 mm

151 5X XXXX	nerez – stainless steel
151 5X XXXX	TiN povlak – TiN surface

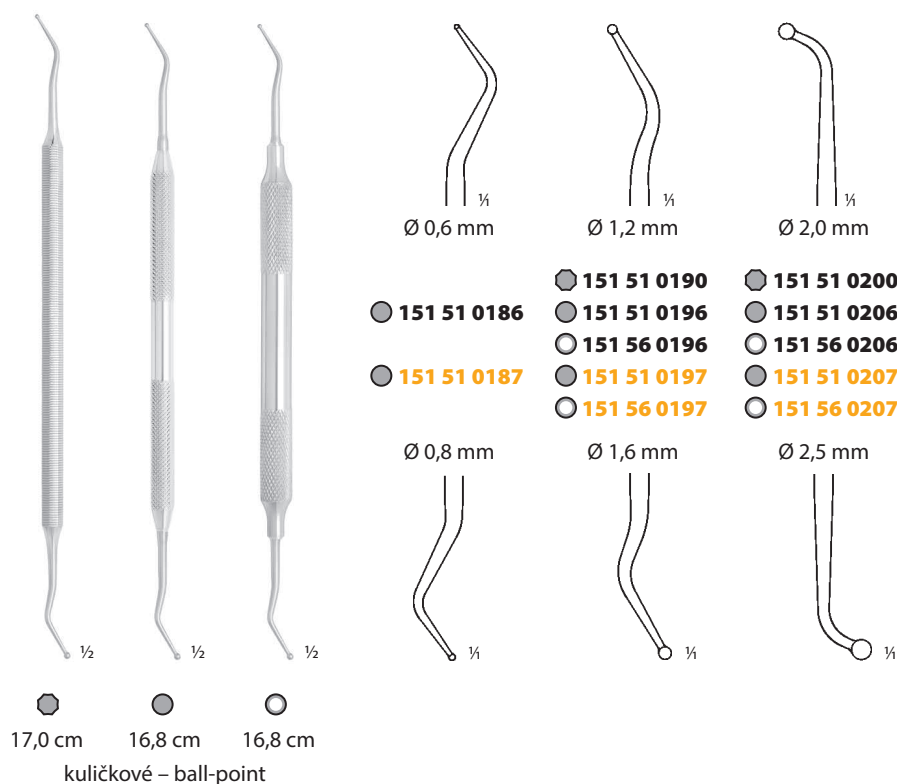
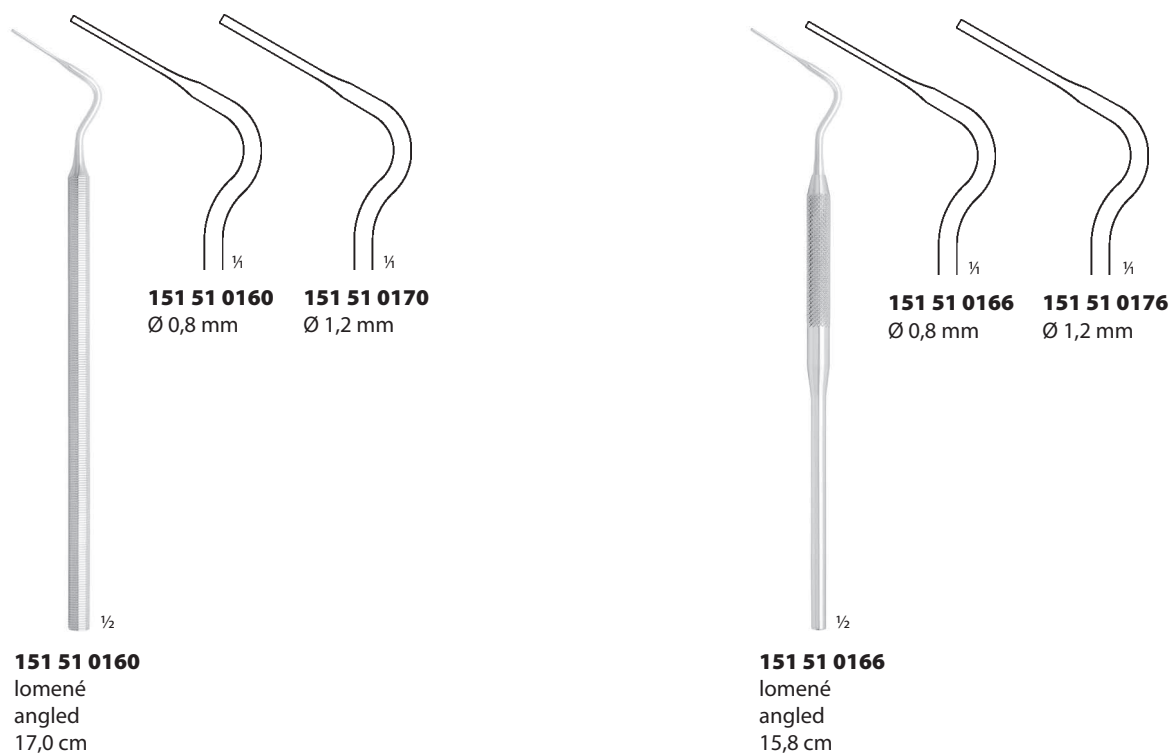

CPÁTKA
FILLING INSTRUMENTSCPÁTKA KOŘENOVÁ
FILLING INSTRUMENTS

●	osmihranné držátko – octagonal handle	5,5 mm
○	plné držátko – round solid handle	Ø 6,0 mm
○	duté držátko – hollow handle	Ø 8,0 mm

151 5X XXXX	nerez – stainless steel
151 5X XXXX	TiN povlak – TiN surface



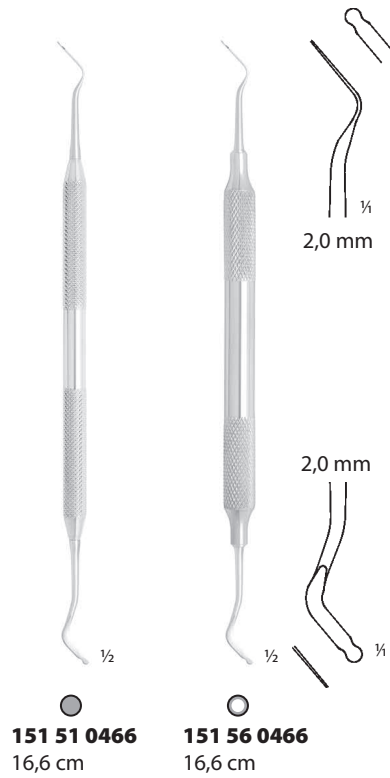

ZAVADĚČE RETRAKČNÍCH VLÁKEN
RETENTIVE FIBRE INSTRUMENTS

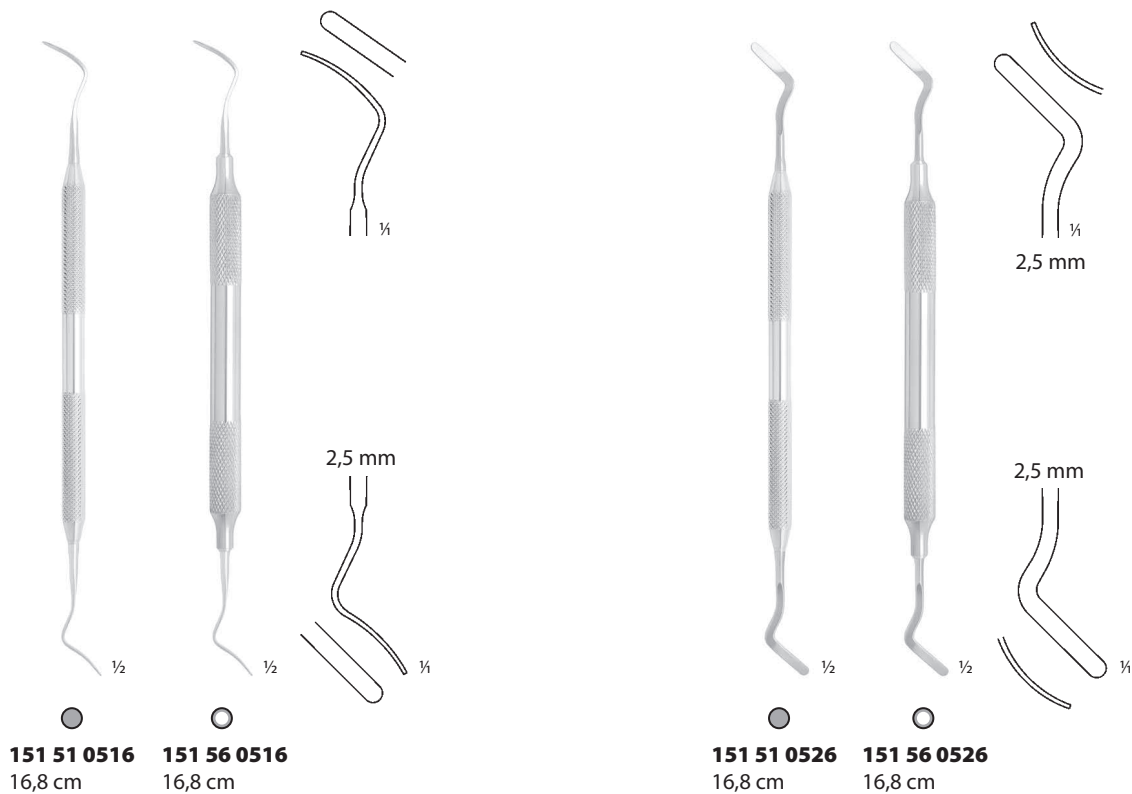

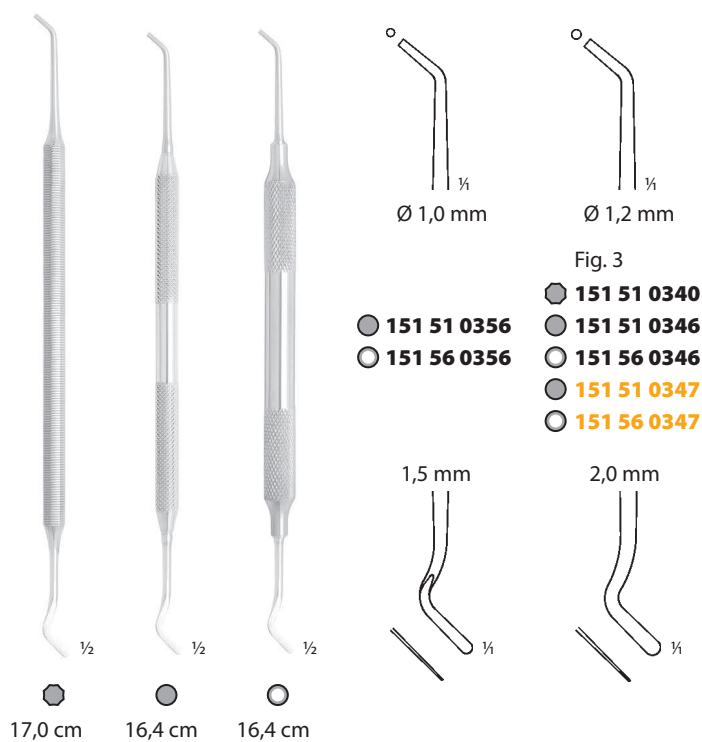

○ osmihránné držátko – octagonal handle	5,5 mm
○ plné držátko – round solid handle	Ø 6,0 mm
○ duté držátko – hollow handle	Ø 8,0 mm

151 5X XXXX	nerez – stainless steel
151 5X XXXX	TiN povlak – TiN surface



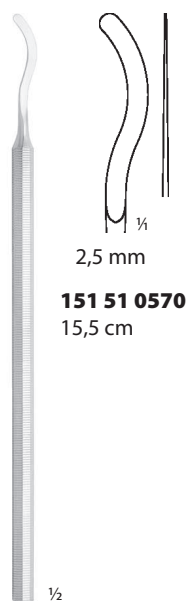

HLADÍTKA PRUŽNÁ
SPATULAS FLEXIBLE

151 51 0570
15,5 cm

151 51 0570
15,5 cm

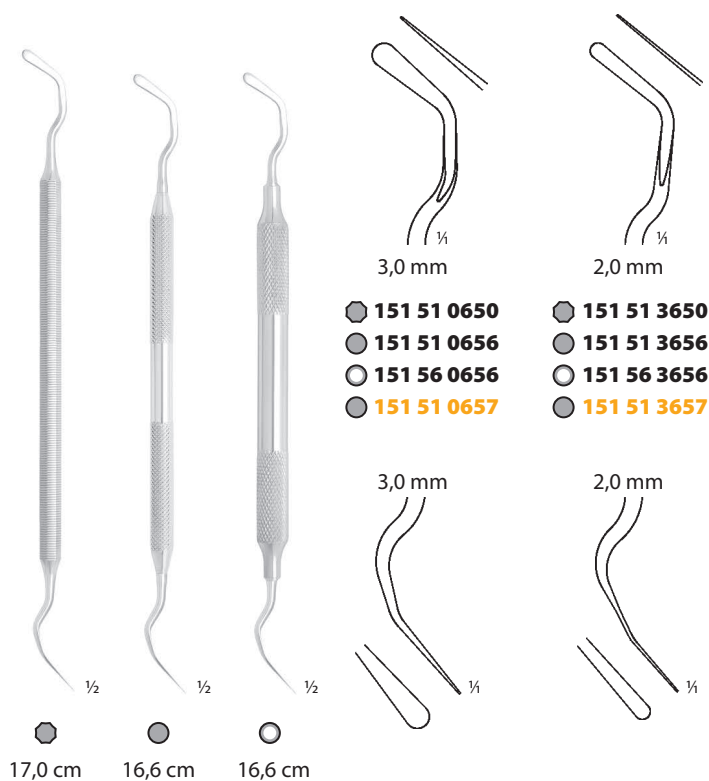
HLADÍTKA 3× LOMENÁ
SPATULAS 3× ANGLED

● **151 51 0650**
● **151 51 0656**
○ **151 56 0656**
● **151 51 0657**

● **151 51 3650**
● **151 51 3656**
○ **151 56 3656**
● **151 51 3657**

● osmihránné držátko – octagonal handle	5,5 mm
○ plné držátko – round solid handle	Ø 6,0 mm
○ duté držátko – hollow handle	Ø 8,0 mm

151 5X XXXX	nerez – stainless steel
151 5X XXXX	TiN povlak – TiN surface



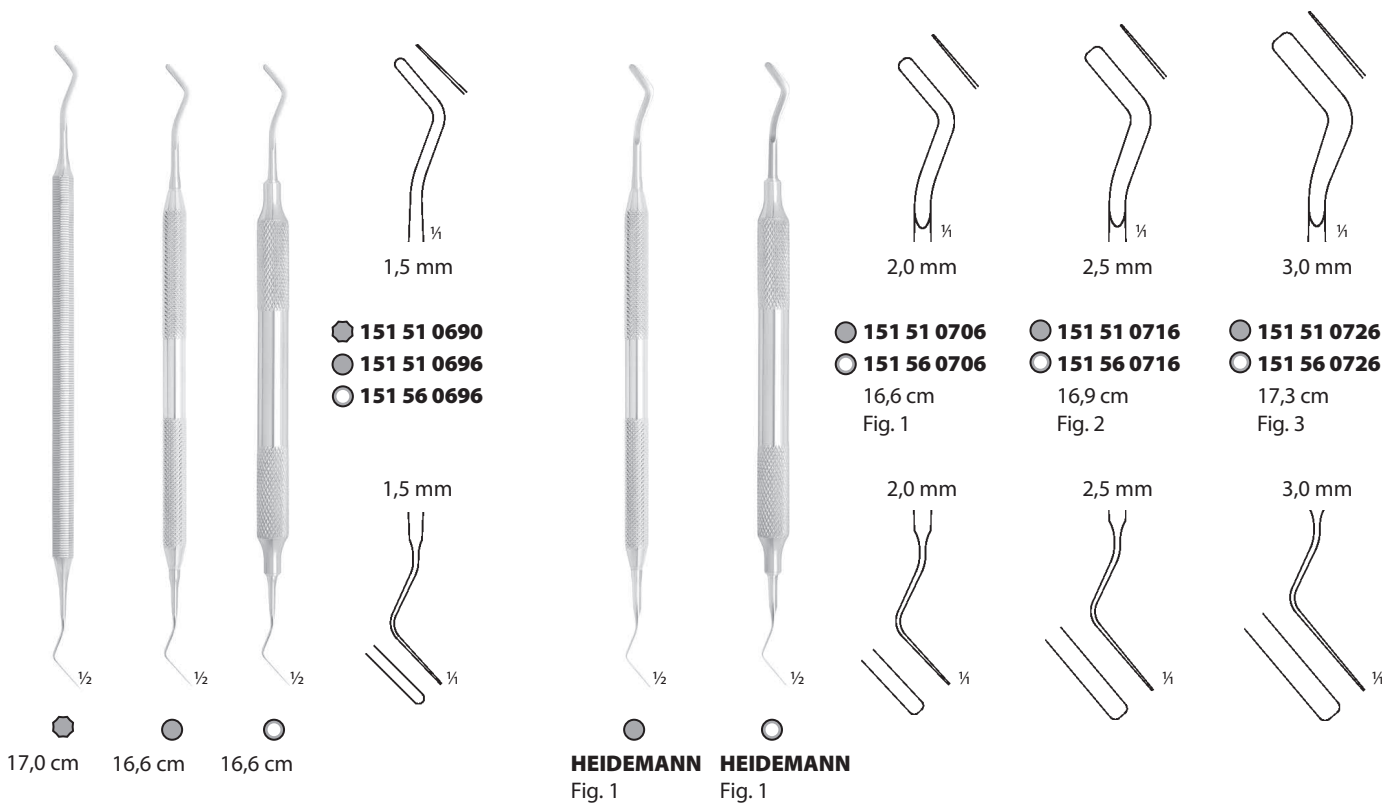
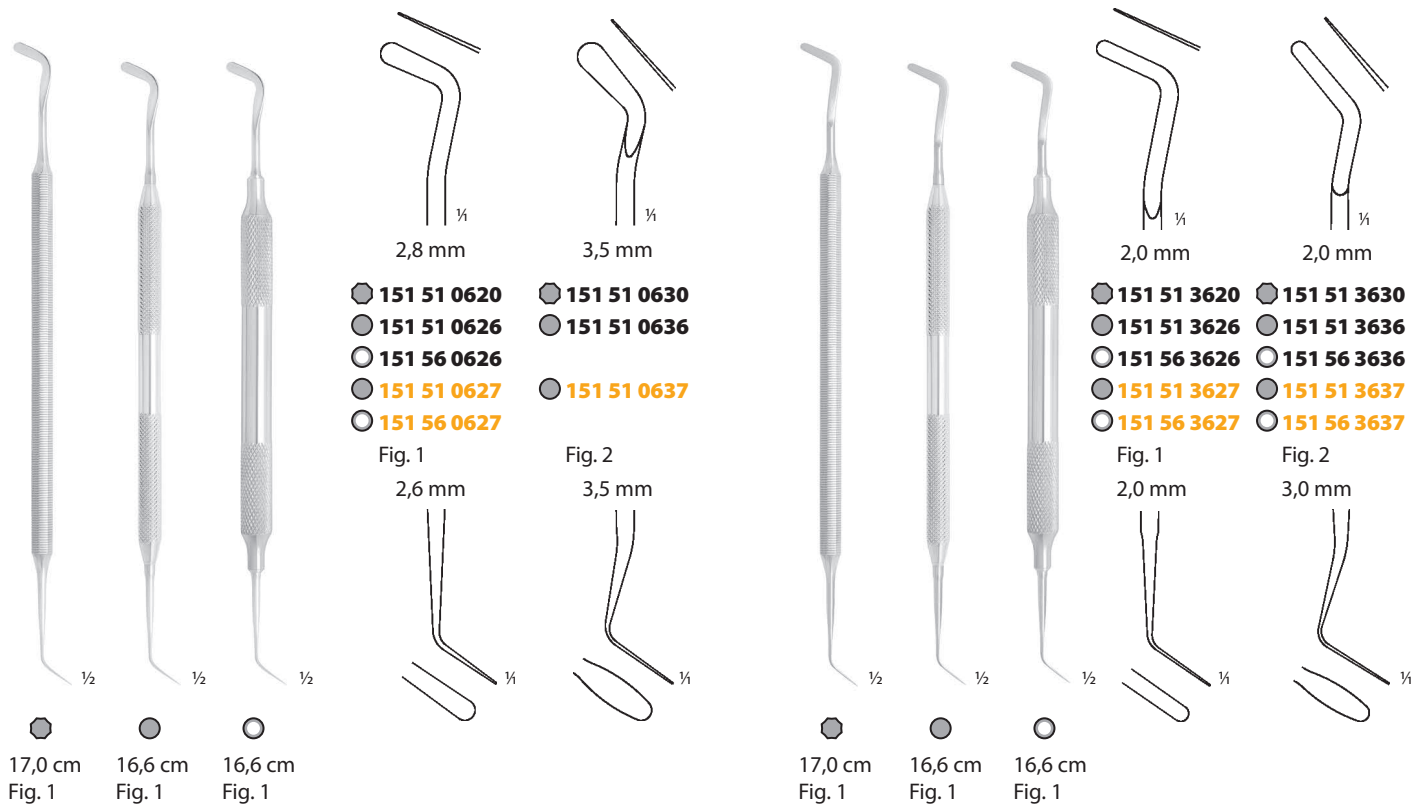

	osmihranné držátko – octagonal handle	5,5 mm
	plné držátko – round solid handle	Ø 6,0 mm
	duté držátko – hollow handle	Ø 8,0 mm

	151 5X XXXX	nerez – stainless steel
	151 5X XXXX	TiN povlak – TiN surface



NÁSTROJE PRO VÝPLNĚ
FILLING INSTRUMENTS

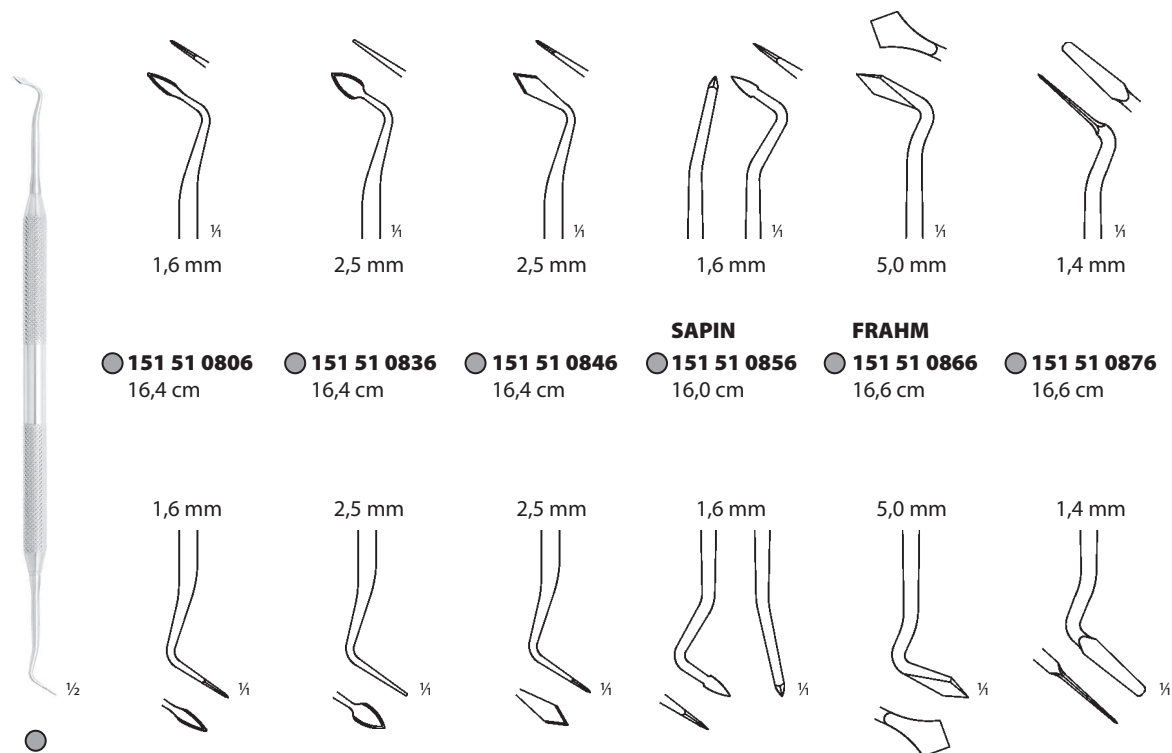

● 151 51 0806 16,4 cm ● 151 51 0836 16,4 cm ● 151 51 0846 16,4 cm ● 151 51 0856 16,0 cm ● 151 51 0866 16,6 cm ● 151 51 0876 16,6 cm

SAPIN FRAHM

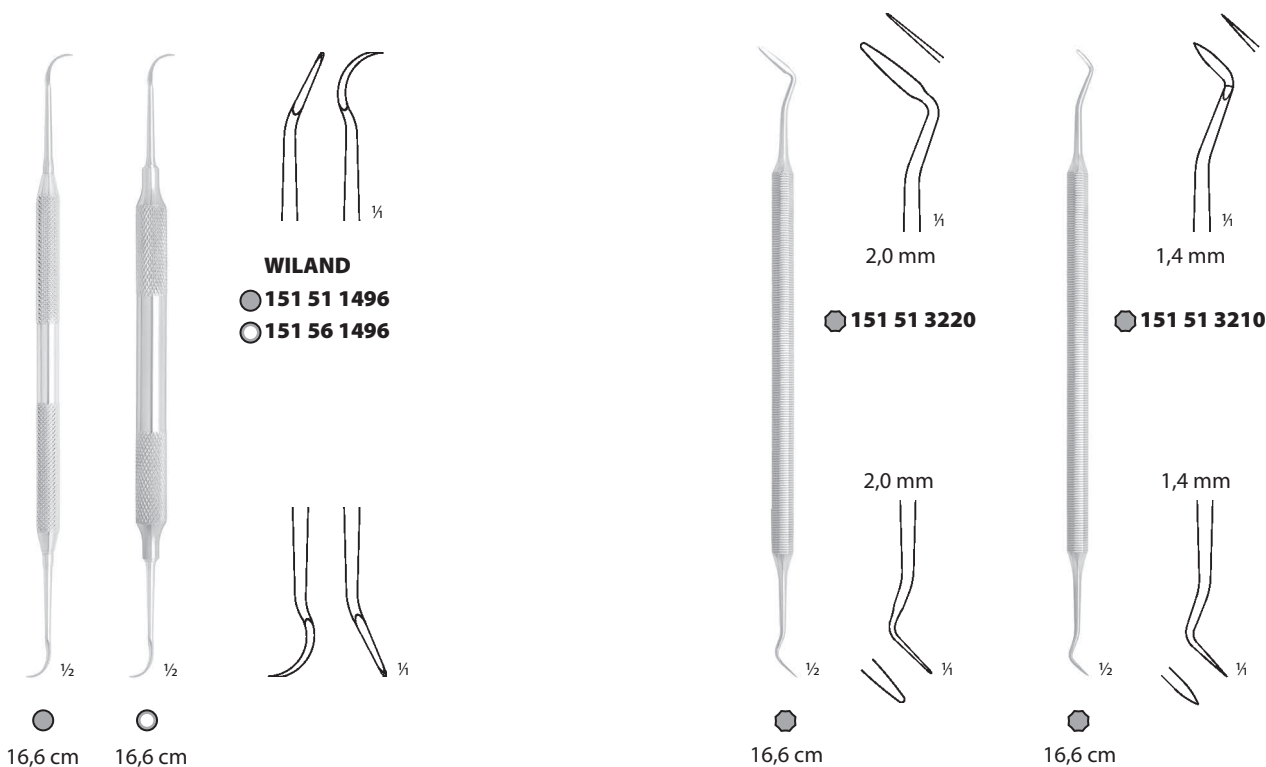

WILAND
● 151 51 1496
○ 151 56 1496

● 151 51 3220 ● 151 51 3210

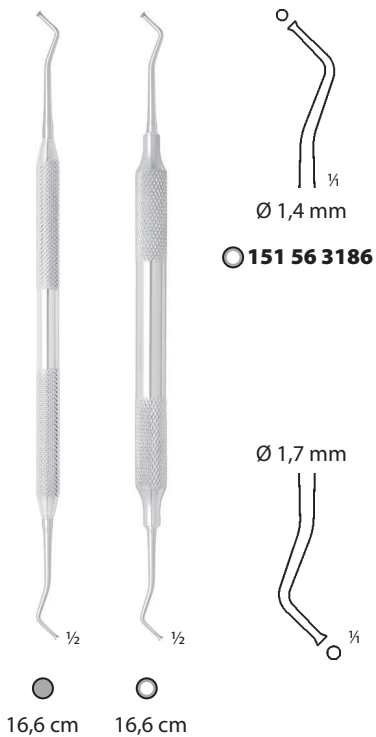

○	osmihranné držátko – octagonal handle	5,5 mm
●	plné držátko – round solid handle	Ø 6,0 mm
○	duté držátko – hollow handle	Ø 8,0 mm

151 5X XXXX	nerez – stainless steel
151 5X XXXX	TiN povlak – TiN surface



NÁSTROJE PRO VÝPLNĚ
FILLING INSTRUMENTS

6,0 mm

5,0 mm

1/2

1/4

**151 51 0616**
16,6 cm

Ø 2,2 mm

2,2 mm

1/2

1/4

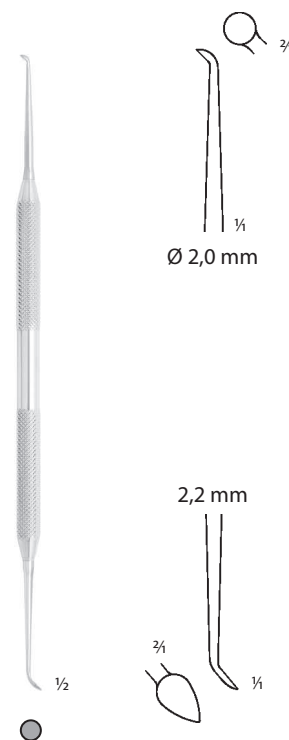
151 51 0896
16,8 cm

Ø 2,0 mm



2,2 mm

1/2

3/4

1/4

DISCOID-CLEOID
151 51 0936
16,8 cm

	osmihranné držátko – octagonal handle	5,5 mm
	plné držátko – round solid handle	Ø 6,0 mm
	duté držátko – hollow handle	Ø 8,0 mm

151 5X XXXX	nerez – stainless steel
151 5X XXXX	TiN povlak – TiN surface



SEPARAČNÍ PÁSKY DIAMANTOVANÉ
SEPARATION DIAMOND STRIPS

120 × 3 mm  ¼

151 51 2020

D40
velmi jemná zrnitost
very fine grain

151 51 2021

D64
jemná zrnitost
fine grain

151 51 2022

D107
střední zrnitost
medium grain

120 × 4 mm  ¼

151 51 2030

D40
velmi jemná zrnitost
very fine grain

151 51 2031

D64
jemná zrnitost
fine grain

151 51 2032

D107
střední zrnitost
medium grain

120 × 6 mm  ¼

151 51 2040

D40
velmi jemná zrnitost
very fine grain

151 51 2041

D64
jemná zrnitost
fine grain

151 51 2042

D107
střední zrnitost
medium grain

120 × 8 mm  ¼

151 51 2051

D64
jemná zrnitost
fine grain

151 51 2052

D107
střední zrnitost
medium grain

POZNÁMKY: Baleno po 1 ks.

NOTES: Packing of 1 pc.

SEPARAČNÍ PÁSKY HLADKÉ
SEPARATION STRIPS – SMOOTH



151 51 1010

120 × 6 × 0,5 mm

151 51 1020

120 × 8 × 0,5 mm

POZNÁMKY: Baleno po 100 ks.

NOTES: Packing of 100 pcs.

SVORKY NA PÁSKY
STRIP CLAMPS



151 51 0970

zahnutá 40°
curved 40°
3,3 cm

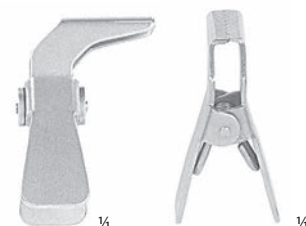

151 51 0980

zahnutá 90°
curved 90°
2,5 cm

PISTOLE NA AMALGAM
AMALGAM PISTOL

151 51 0760
kovový píst
metal piston
15,0 cm



151 51 0770
kovový píst
metal piston
13,0 cm



Lopatka na míchání
Mixing spatula
121 52 0080
21,0 cm
27 mm

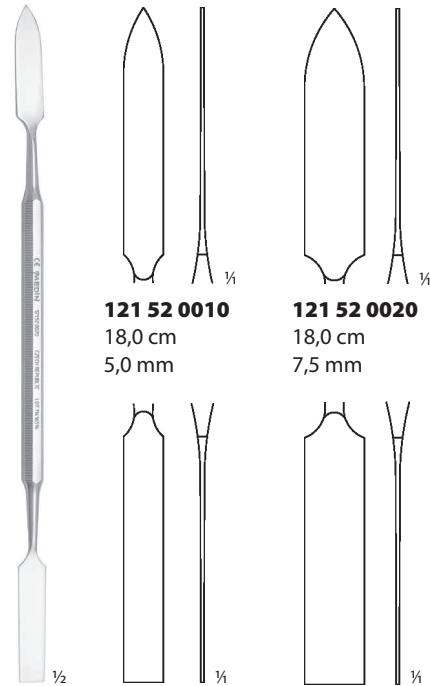

121 52 0010
18,0 cm
5,0 mm

121 52 0020
18,0 cm
7,5 mm

Lopatka na cement
Cement spatula
121 52 0020
oboustranná
double faced
18,0 cm



IVORY
156 52 0010
malá
small
2,5 cm



IVORY
156 52 0020
střední
medium
3,6 cm



IVORY
156 52 0030
velká
large
3,5 cm

POZNÁMKY: Baleno po 20 ks.
NOTES: Packing of 20 pcs.



IVORY
Napínač matric
Matrix retainer
156 52 0050
7,0 cm



Matrice pásková
Matrix band
156 91 0001 5 mm 1 m
156 91 0002 6 mm 1 m
156 91 0003 7 mm 1 m

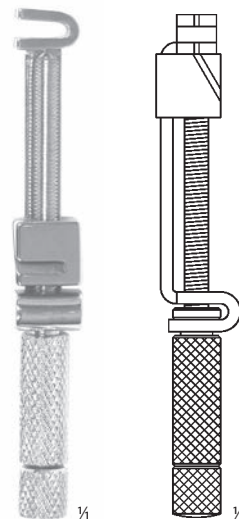

Napínač matric univerzální
Universal retainer
156 52 0300
6,4 cm

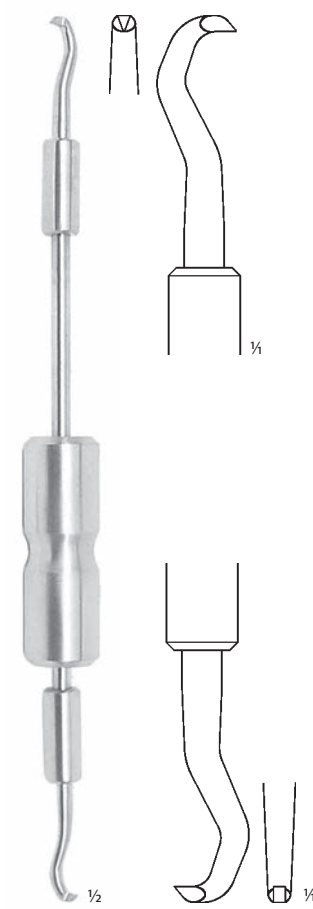
NÁSTROJ NA SNÍMÁNÍ KORUNEK
CROWN REMOVER**123 50 0610**
23,3 cm



D

PARODONTOLOGIE
PERIODONTIA

Sondy, pátridla	Probes	99
Kyrety	Curettes	100–103
Nástroje na zubní kámen	Scalers	104–107

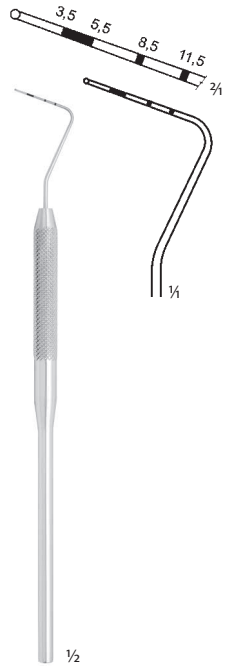

Sonda parodontologická
Periodontal probe
133 50 0106
3,5; 5,5; 8,5; 11,5 mm
WHO
15,2 cm

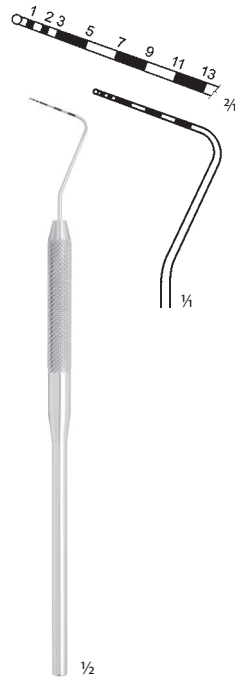

Sonda parodontologická
Periodontal probe
133 50 0116
1; 2; 3; 5; 7; 9; 11; 13 mm
15,2 cm

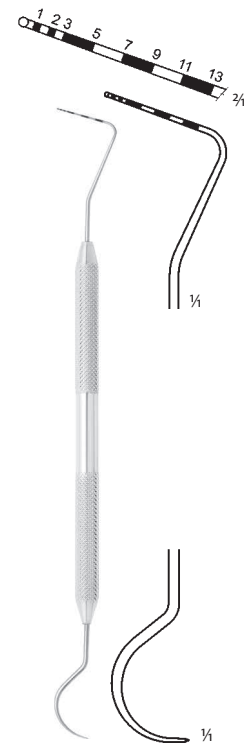

Sonda parodontologická s pátradlem
Periodontal and dental probe
133 99 0177
15,7 cm

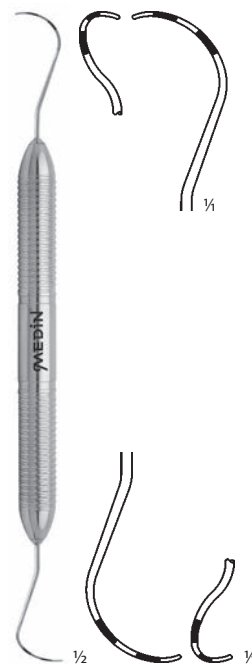

NABERS
Furkační sonda
Furcation probe
133 58 0230
3-6-9-12
17,2 cm



GRACEY 1/2
126 58 0056
17,4 cm



GRACEY 3/4
126 58 0066
17,4 cm



GRACEY 5/6
126 58 0076
17,3 cm



GRACEY 7/8
126 58 0086
17,0 cm



GRACEY 9/10
126 58 0146
16,5 cm



GRACEY 11/12
126 58 0106
17,2 cm



GRACEY 13/14
126 58 0116
17,0 cm



GRACEY 15/16
126 58 0126
17,1 cm

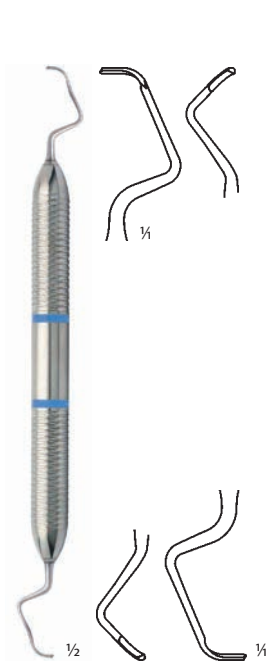

GRACEY 17/18
126 58 0136
15,6 cm

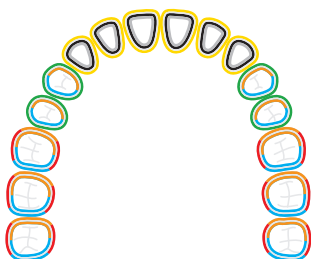

- GRACEY 1/2
- GRACEY 3/4
- GRACEY 5/6
- GRACEY 7/8
- GRACEY 9/10
- GRACEY 11/12
- GRACEY 13/14
- GRACEY 15/16
- GRACEY 17/18

řezáky, špičáky, premoláry
řezáky, špičáky, premoláry
řezáky, špičáky, premoláry
premoláry, moláry
moláry
moláry – meziální plochy
moláry – distální plochy
moláry – meziální plochy
moláry – distální plochy

incisors, premolars
incisors, premolars
incisors, premolars
premolars, molars
molars
molars' mesial surfaces
molars' distal surfaces
molars' mesial surfaces
molars' distal surfaces



MINI GRACEY 1/2
126 58 1056
17,6 cm



MINI GRACEY 3/4
126 58 1066
17,4 cm



MINI GRACEY 5/6
126 58 1076
17,5 cm



MINI GRACEY 7/8
126 58 1086
17,1 cm



MINI GRACEY 9/10
126 58 1146
16,7 cm



MINI GRACEY 11/12
126 58 1106
17,4 cm



MINI GRACEY 13/14
126 58 1116
17,4 cm



MINI GRACEY 15/16
126 58 1126
17,2 cm

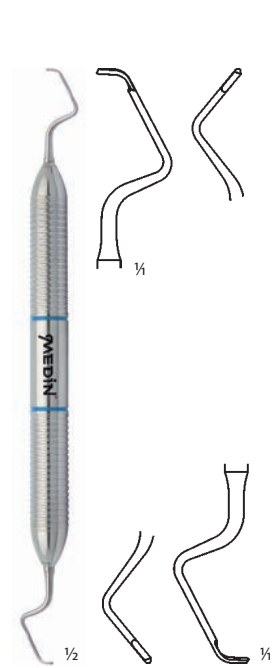

MINI GRACEY 17/18
126 58 1136
15,8 cm

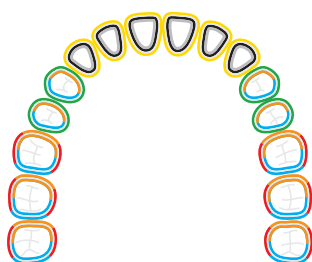

- MINI GRACEY 1/2
- MINI GRACEY 3/4
- MINI GRACEY 5/6
- MINI GRACEY 7/8
- MINI GRACEY 9/10
- MINI GRACEY 11/12
- MINI GRACEY 13/14
- MINI GRACEY 15/16
- MINI GRACEY 17/18

řezáky, špičáky, premoláry
řezáky, špičáky, premoláry
řezáky, špičáky, premoláry
premoláry, moláry
moláry
moláry – meziální plochy
moláry – distální plochy
moláry – meziální plochy
moláry – distální plochy

incisors, premolars
incisors, premolars
incisors, premolars
premolars, molars
molars
molars' mesial surfaces
molars' distal surfaces
molars' mesial surfaces
molars' distal surfaces



Soubor parodontologických nástrojů, set 1
Set of periodontal instruments, set 1

139 50 0770

		ks / pcs
126 58 0056	Gracey kyreta 1/2; 17,4 cm	1
126 58 0066	Gracey kyreta 3/4; 17,4 cm	1
126 58 0076	Gracey kyreta 5/6; 17,3 cm	1
126 58 0086	Gracey kyreta 7/8; 17,0 cm	1
126 58 0096	Scaler oboustranný; 16,7 cm	1
126 58 0106	Gracey kyreta 11/12; 17,2 cm	1
126 58 0116	Gracey kyreta 13/14; 17,0 cm	1
126 58 0126	Gracey kyreta 15/16; 17,1 cm	1
126 58 0136	Gracey kyreta 17/18; 15,6 cm	1
126 58 0146	Gracey kyreta 9/10; 16,5 cm	1

Soubor parodontologických nástrojů, set 2
Set of periodontal instruments, set 2

139 50 0780

		ks / pcs
126 58 0076	Gracey kyreta 5/6; 17,3 cm	1
126 58 0086	Gracey kyreta 7/8; 17,0 cm	1
126 58 0096	Scaler oboustranný; 16,7 cm	1
126 58 0106	Gracey kyreta 11/12; 17,2 cm	1
126 58 0116	Gracey kyreta 13/14; 17,0 cm	1

Soubor parodontologických nástrojů mini, set 1
Set of mini periodontal instruments, set 1

139 50 0810

		ks / pcs
126 58 1056	Mini Gracey kyreta 1/2; 17,6 cm	1
126 58 1066	Mini Gracey kyreta 3/4; 17,4 cm	1
126 58 1076	Mini Gracey kyreta 5/6; 17,5 cm	1
126 58 1086	Mini Gracey kyreta 7/8; 17,1 cm	1
126 58 0096	Scaler oboustranný; 16,7 cm	1
126 58 1106	Mini Gracey kyreta 11/12; 17,4 cm	1
126 58 1116	Mini Gracey kyreta 13/14; 17,4 cm	1
126 58 1126	Mini Gracey kyreta 15/16; 17,2 cm	1
126 58 1136	Mini Gracey kyreta 17/18; 15,8 cm	1
126 58 1146	Mini Gracey kyreta 9/10; 16,7 cm	1

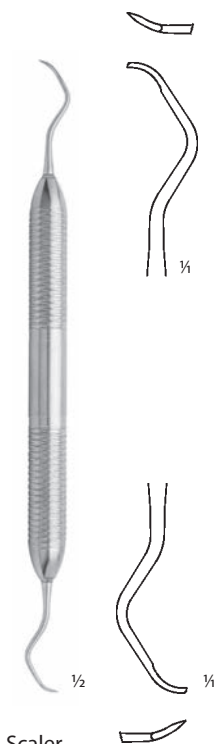

Scaler
Scaler
126 58 0096
16,7 cm

PŘÍSLUŠENSTVÍ PRO PARODONTOLOGII
PERIODONTAL ACCESSORIES



Brousek na ostření kyret
Sharpening stone for curettes
126 91 0162



Testovací tyčinka PMMA
Plastic test stick
126 53 0010
80 mm

NÁSTROJE NA ZUBNÍ KÁMEN
SCALERS

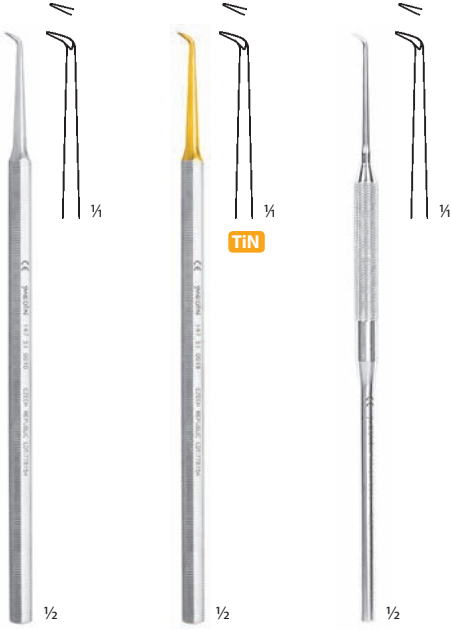

147 51 0010
15,5 cm

147 51 0018
15,5 cm

147 51 0016
15,5 cm

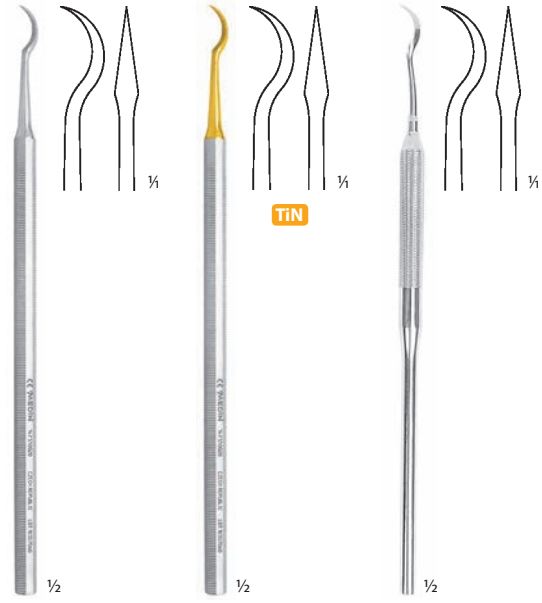

147 51 0020
15,5 cm

147 51 0028
15,5 cm

147 51 0026
15,5 cm

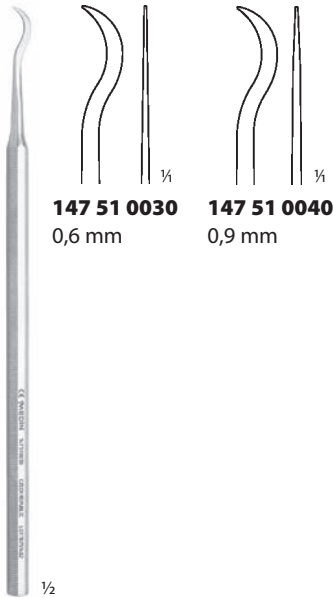

147 51 0030
0,6 mm

147 51 0040
0,9 mm

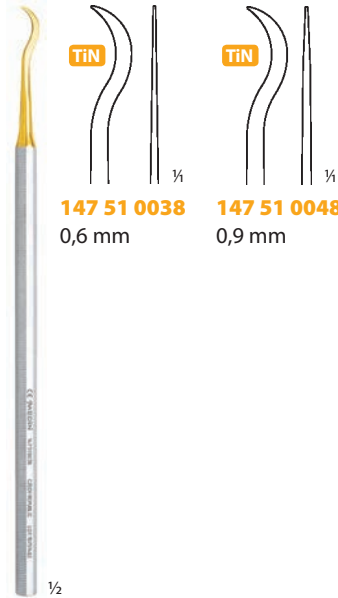

147 51 0038
0,6 mm

147 51 0048
0,9 mm

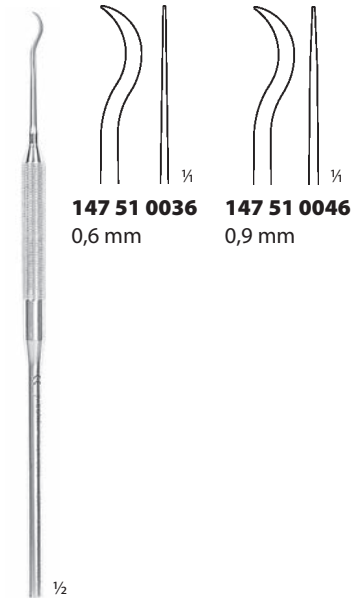

147 51 0036
0,6 mm

147 51 0046
0,9 mm

147 51 0030
15,5 cm

147 51 0038
15,5 cm

147 51 0036
15,5 cm



147 51 0060
2× lomený
double angled
15,5 cm

147 51 0068
2× lomený
double angled
15,5 cm

147 51 0066
2× lomený
double angled
15,5 cm

ŠKRABKY NA ZUBNÍ KÁMEN
SCALERS

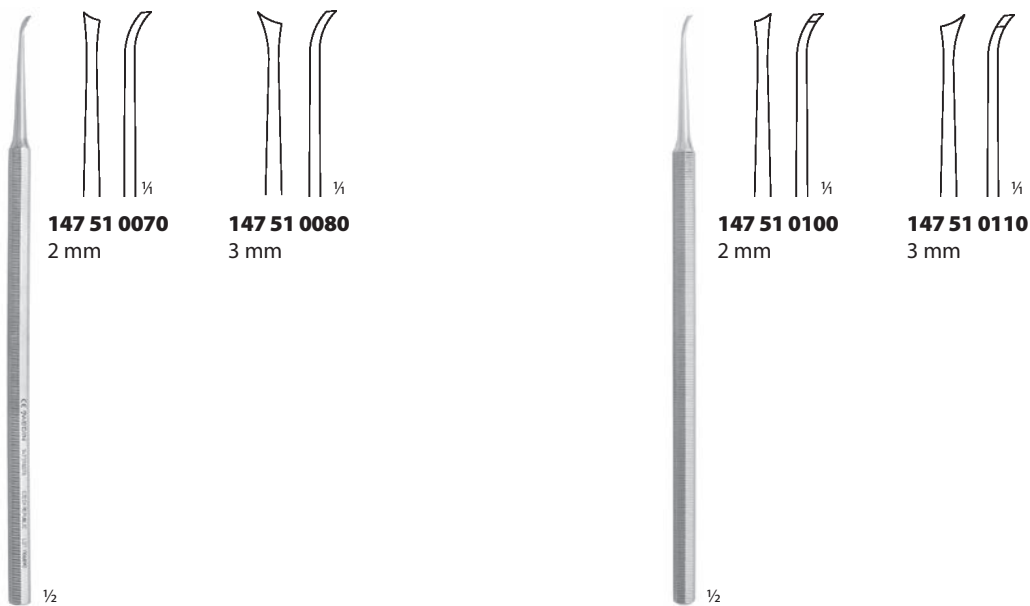

147 51 0070
2 mm

147 51 0080
3 mm

147 51 0100
2 mm

147 51 0110
3 mm

147 51 0070
pravá
right
15,5 cm

147 51 0100
levá
left
15,5 cm

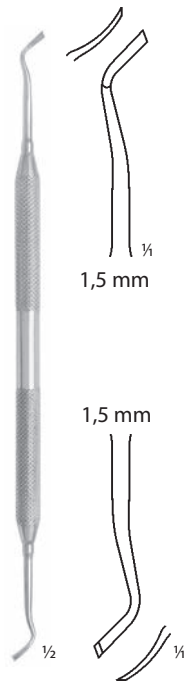
ZEŠIKMOVAČE GINGIVÁLNÍCH OKRAJŮ
GINGIVAL MARGIN TRIMMERS

147 51 0806
distální
distal
16,6 cm

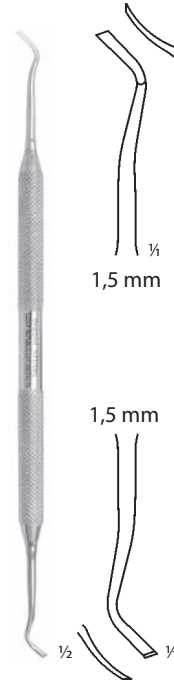

147 51 0816
meziální
mesial
16,5 cm

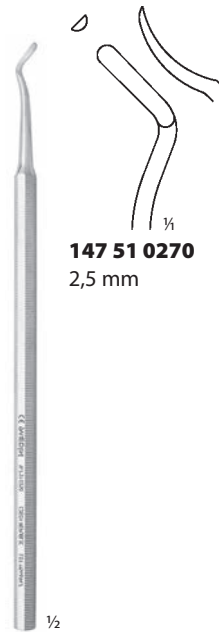

147 51 0270
levý
left
15,5 cm

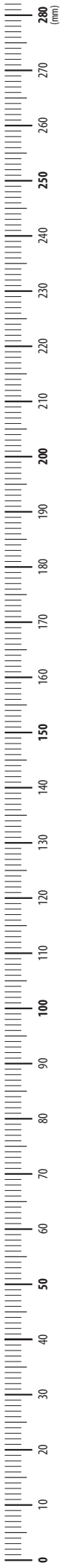

A series of horizontal lines extending across the page, providing a template for writing or drawing. The lines are evenly spaced and correspond to the 10 mm intervals of the ruler on the left.



E

LABORATOŘ
LABORATORY

Pinzety	Forceps	111
Nůžky	Scissors	112
Pilky	Saws	112
Kleště úchopné	Grasping Forceps	113
Kleště štípací	Cutting Rongeurs	113
Kleště ohýbací	Bending Forceps	113
Lopatky	Spatulas	114
Lžičky laboratorní	Laboratory Spoons	114
Nástroje modelovací	Modelling Instruments	115
Kladiva	Mallets	116
Třmeny	Claps	117
Pomůcky pro lití	Casting Devices	118
Otiskovací lžice	Impression Trays	119–120



114 52 0030
jemná
fine
12,5 cm
0,3 mm



114 52 0050
jemná
fine
11,0 cm
0,3 mm

Pinzeta laboratorní
Laboratory forceps
114 52 0030
12,5 cm

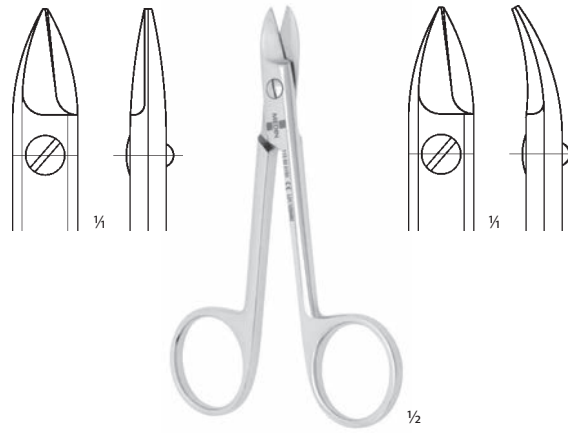
NŮŽKY NA KORUNKY
CROWN SCISSORS

113 52 0150
rovné
straight

11,0 cm

113 52 0160
zahnuté
curved

PILKY STOMATOLOGICKÉ
STOMATOLOGICAL SAWS

Upínací rám pilky stomatologické
Frame of stomatological saw
127 50 0150
190 × 65 cm

List k pilce stomatologické
Blade of stomatological saw
127 50 0001
7,3 cm



Kleště na kelímky
Crucible forceps
117 52 0770
50,0 cm



Kleště na kelímky
Crucible forceps
117 52 0780
27,5 cm

KLEŠTĚ ŠTÍPACÍ A OHÝBACÍ NA DRÁT
WIRE CUTTING AND BENDING FORCEPS



univerzální kramponové
universal bending pliers

117 52 0700
13,5 cm
pro tvrdý drát do průměru 0,8 mm
for hard wires up to diameter 0,8 mm



116 91 0001
14,5 cm
pro měkký drát do průměru 1,5 mm
pro tvrdý drát do průměru 1,0 mm
for soft wires up to diameter 1,5 mm
for hard wires up to diameter 1,0 mm



116 91 0005
17,0 cm
pro tvrdý drát do průměru 1,5 mm
for hard wires up to diameter 1,5 mm

LOPATKY
SPATULAS

Nůž na sádku
Plaster knife
121 52 0050
18,0 cm



Lopatka na sádku
Plaster spatula
121 52 0060
16,8 cm
40/30 mm



Lopatka na míchání
Mixing spatula
121 52 0080
21,0 cm
27 mm



Lopatka na cement
Cement spatula
121 52 0020
18,0 cm

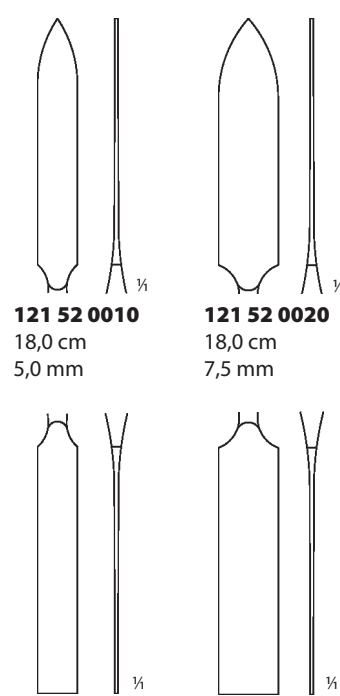

121 52 0010
18,0 cm
5,0 mm

121 52 0020
18,0 cm
7,5 mm

LŽIČKY LABORATORNÍ
LABORATORY SPOONS

125 53 0010
15,0 cm



125 53 0020
20,0 cm

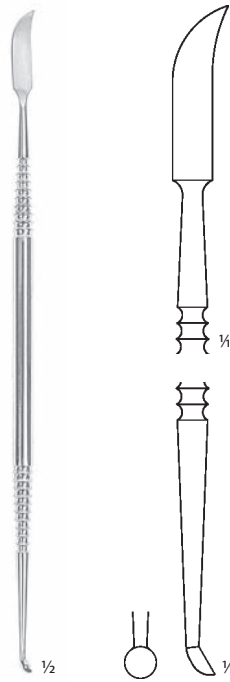

LE CRON
155 52 0180
17,5 cm

NOŽE MODELOVACÍ
MODELLING KNIVES



155 52 0212
13,0 cm



155 52 0222
17,4 cm



Kladívko laboratorní
Laboratory mallet
128 52 0110
vypouklé, leštěné
convex, polished
26,0 cm



Kladívko laboratorní
Laboratory mallet
128 52 0111
rovné, matované
straight, mat
26,0 cm

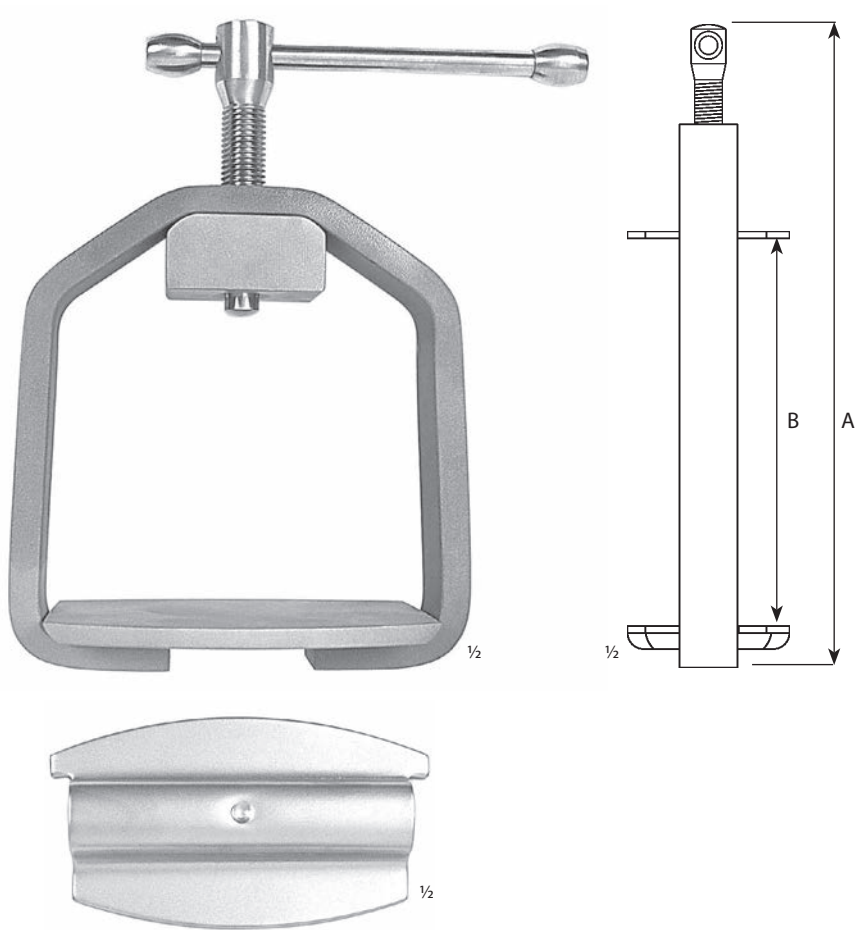

157 52 0030 Třmen pro jednu kyvetu
157 52 0040 Třmen pro dvě kyvety
157 52 0050 Třmen pro tři kyvety

Clap for one flask
 Clap for two flasks
 Clap for three flasks

A	B
17,0 cm	6,4 cm
22,5 cm	12,0 cm
28,0 cm	17,5 cm

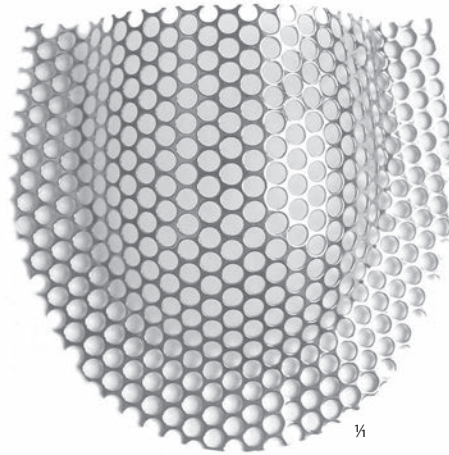
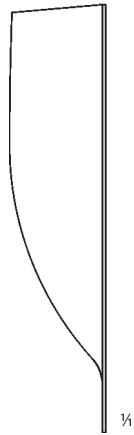

152 52 1900
zlacená
gold plated
60 × 54 × 12 mm

152 52 1910
nerezová
stainless
60 × 54 × 12 mm

OTISKOVACÍ LŽÍCE PRO HORNÍ OZUBENOU ČELIST
IMPRESSION TRAYS FOR TOOTHED UPPER JAWS

s retenčním okrajem
with retentive edge

154 52 9010 H1
154 52 9011 H2
154 52 9012 H3
154 52 9013 H4



s retenčním okrajem, perforované
with retentive edge, perforated

154 52 9018 HX1
154 52 9019 HX2
154 52 9020 HX3
154 52 9021 HX4



perforované
perforated

154 52 0110 BOX1
154 52 0120 BOX2
154 52 0130 BOX3
154 52 0140 BOX4

OTISKOVACÍ LŽÍCE PRO DOLNÍ OZUBENOU ČELIST
IMPRESSION TRAYS FOR TOOTHED LOWER JAWS

s retenčním okrajem
with retentive edge

154 52 9014 D1
154 52 9015 D2
154 52 9016 D3
154 52 9017 D4



s retenčním okrajem, perforované
with retentive edge, perforated

154 52 9022 DX1
154 52 9023 DX2
154 52 9024 DX3
154 52 9025 DX4



perforované
perforated

154 52 0260 FX1
154 52 0270 FX2
154 52 0280 FX3
154 52 0290 FX4

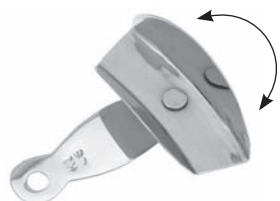
OTISKOVACÍ LŽÍCE
IMPRESSION TRAYS

154 52 0600
korunková
crown



154 52 0560
poloviční levá perforovaná
for partial impressions left perforated
PLX



154 52 0550
poloviční pravá perforovaná
for partial impressions right perforated
PPX

Otiskovací lžice
Impression trays

154 52 1550
soubor
set

154 52 0110	BOX1	1x
154 52 0120	BOX2	1x
154 52 0130	BOX3	1x
154 52 0140	BOX4	1x
154 52 0260	FX1	1x
154 52 0270	FX2	1x
154 52 0280	FX3	1x
154 52 0550	PPX	1x
154 52 0560	PLX	1x

OTISKOVACÍ LŽÍCE – DĚTSKÉ
IMPRESSION TRAYS – CHILDREN

pro horní čelist, perforovaná
for upper jaws, perforated

154 52 0360 DHX1
154 52 0370 DHX2
154 52 0380 DHX3



pro dolní čelist, perforovaná
for lower jaws, perforated

154 52 0460 DDX1
154 52 0470 DDX2
154 52 0480 DDX3

Otiskovací lžice dětské
Impression trays for children
154 52 1650
soubor
set

154 52 0360	DHX1	1x
154 52 0370	DHX2	1x
154 52 0380	DHX3	1x
154 52 0460	DDX1	1x
154 52 0470	DDX2	1x
154 52 0480	DDX3	1x

OTISKOVACÍ LŽÍCE PRO BEZZUBOU ČELIST
IMPRESSION TRAYS FOR TOOTHLESS JAWS

horní, perforovaná
upper, perforated

154 52 0610 FOX1
154 52 0620 FOX2
154 52 0630 FOX3
154 52 0640 FOX4



dolní, perforovaná
lower, perforated

154 52 0660 UUX1
154 52 0670 UUX2
154 52 0680 UUX3
154 52 0690 UUX4

OTISKOVACÍ LŽÍCE PRO ČÁSTEČNĚ OZUBENOU ČELIST
IMPRESSION TRAYS FOR PARTIALLY TOOTHED JAWS

154 52 0790
horní, perforovaná
upper, perforated
BOXC3



154 52 0820
dolní, perforovaná
lower, perforated
FXC2



154 52 0830
dolní, perforovaná
lower, perforated
FXC3



STERILIZACE A POMOCNÉ VYBAVENÍ

STERILIZATION AND ACCESSORIES



Nádobky	Boxes	123
Držátka ubrousku	Napkin Holders	123
Toulce	Quivers	124
Kazety, nádobky	Cassettes, Bowls	125
Krabičky	Boxes	125–126
Tácky	Trays	127



Nádobka na vatu s pružinou
Cotton wool box with spring
159 53 0050
7,5 cm
Ø 5,0 cm



Nádobka na vatové odpady
Cotton wool bin
159 53 0060
6,5 cm
Ø 5,0 cm

DRŽÁTKA UBROUSKU
NAPKIN HOLDERS



Držátko ubrousku řetizkové
Napkin holder with metal chain
159 53 0100
celková délka 50,0 cm
total length 50,0 cm
kovové svorky
metal clips

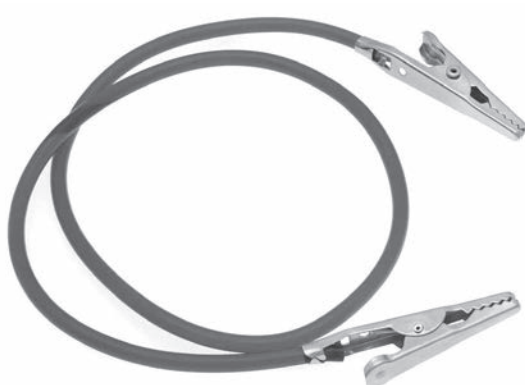

Držátko ubrousku uh
Napkin holder
159 53 0110
celková délka 50,0 cm
total length 50,0 cm
kovové svorky Aligátor
metal clips Aligator



Držátko ubrousku řetizkové
Napkin holder with metal chain
159 53 0120
celková délka 32,0 cm
total length 32,0 cm
kovové svorky Aligátor
metal clips Aligator



136 39 0010
4,7×9,0 cm
na pinzety, leštěný
for tweezers, polished



136 39 0020
6,6×20,0 cm
na podávkové kleště, leštěný
for forceps, polished

TOULCE S PODSTAVCEM QUIVERS WITH STAND



136 39 0050
70×110 mm
na pinzety
for tweezers



136 39 0060
70×200 mm
na kleště
for forceps



136 39 0070
50×90 mm
na pinzety
for tweezers

KAZETA S DRŽÁKEM
CASSETTE WITH HOLDER



Držák
Holder
139 50 0150
aluminium
21,0 × 9,6 × 1,6 cm



Kazeta s držákem
Cassette with holder
139 50 0160
aluminium
22,0 × 10,5 × 3,6 cm



Kazeta
Cassette
139 50 0170
aluminium
22,0 × 10,5 × 3,6 cm

NÁDOBKY
BOWLS



136 39 0260
nerez – stainless steel
175×100×25 mm



136 39 0270
nerez – stainless steel
90×40 mm



136 39 0320
nerez – stainless steel
82×30 mm

KRABÍČKY KULATÉ
BOXES ROUND



136 39 0213 40 × 13 mm
136 39 0211 65 × 15 mm
136 39 0214 80 × 18 mm
136 39 0215 90 × 20 mm
136 39 0216 100 × 20 mm
nerez – stainless steel



Krabička perforovaná
Box round
136 39 0212
nerez – stainless steel
62×13 mm

KRABÍČKY PRO HORKOVZDUŠNOU STERILIZACI
BOXES FOR DRY-HEAT STERILIZATION

136 39 0140
nerez – stainless steel
200×100×30 mm



136 39 0150
nerez – stainless steel
170×70×30 mm



136 39 0160
nerez – stainless steel
200×100×40 mm



136 39 0170
nerez – stainless steel
210×115×45 mm



136 39 0180
nerez – stainless steel
dvojití víčko – double lid
210×110×25 mm



136 39 0190
nerez – stainless steel
210×115×45 mm



136 39 0200
nerez – stainless steel
na katetry – for catheters
300×80×40 mm



136 39 0220
nerez – stainless steel
350×90×50 mm



136 39 0230
nerez – stainless steel
230×150×60 mm



136 39 0240
nerez – stainless steel
300×200×50 mm



136 39 0250
nerez – stainless steel
200×150×45 mm

POZNÁMKY: vnitřní rozměry
NOTES: inner dimensions



136 39 0110
nerez – stainless steel
180×120×15 mm



136 39 0330
nerez – stainless steel
nestohovatelný – unstackable



136 39 0340
nerez – stainless steel
180×90×15 mm



136 39 0350
nerez – stainless steel
200×100×30 mm



136 39 0360
nerez – stainless steel
stohovatelný – stackable
190×100×10 mm



136 39 0370
nerez – stainless steel
280×180×25 mm



136 39 0380
nerez – stainless steel
350×250×25 mm

POZNÁMKY: vnitřní rozměry
NOTES: inner dimensions



136 39 0210
nerez – stainless steel
92×40×17 mm

číslo – number	název	item	strana – page
112	Nástroje řezné	Cutting Instruments	
112 38 0010	Dieffenbach skalpel oční bříškatý; 1,7 cm, fig. 1	Dieffenbach knife; 1,7 cm, fig. 1	39
112 38 0020	Dieffenbach skalpel oční bříškatý; 2,0 cm, fig. 2	Dieffenbach knife; 2,0 cm, fig. 2	39
112 38 0030	Dieffenbach skalpel oční bříškatý; 2,5 cm, fig. 4	Dieffenbach knife; 2,5 cm, fig. 4	39
112 38 0040	Dieffenbach skalpel oční bříškatý; 3,0 cm, fig. 5	Dieffenbach knife; 3,0 cm, fig. 5	39
112 38 0110	Dieffenbach skalpel oční hrotnatý; 1,7 cm, fig. 7	Dieffenbach knife; 1,7 cm, fig. 7	39
112 38 0120	Dieffenbach skalpel oční hrotnatý; 2,0 cm, fig. 8	Dieffenbach knife; 2,0 cm, fig. 8	39
112 38 0130	Dieffenbach skalpel oční hrotnatý; 2,5 cm, fig. 9	Dieffenbach knife; 2,5 cm, fig. 9	39
112 38 0140	Dieffenbach skalpel oční hrotnatý; 3,0 cm, fig. 10	Dieffenbach knife; 3,0 cm, fig. 10	39
112 91 0002	Držátko skalpelových čepelek s měřítkem; fig. 3	Scalpel handle with scale fig. 3	40
112 91 0003	Držátko skalpelových čepelek; fig. 3	Scalpel handle fig. 3	40
112 91 0004	Držátko skalpelových čepelek; fig. 4	Scalpel handle fig. 4	40, 125
112 91 0005	Držátko skalpelových čepelek; fig. 3l	Scalpel handle fig. 3l	40
112 91 0010	Čepelka skalpelová; fig. 10 (baleno po 100 ks)	Scalpel blades fig. 10 (pck=100 pcs)	41
112 91 0011	Čepelka skalpelová; fig. 11 (baleno po 100 ks)	Scalpel blades fig. 11 (pck=100 pcs)	41
112 91 0012	Čepelka skalpelová; fig. 12 (baleno po 100 ks)	Scalpel blades fig. 12 (pck=100 pcs)	41
112 91 0013	Čepelka skalpelová; fig. 13 (baleno po 100 ks)	Scalpel blades fig. 13 (pck=100 pcs)	41
112 91 0015	Čepelka skalpelová; fig. 15 (baleno po 100 ks)	Scalpel blades fig. 15 (pck=100 pcs)	41
112 91 0018	Čepelka skalpelová; fig. 18 (baleno po 100 ks)	Scalpel blades fig. 18 (pck=100 pcs)	41
112 91 0020	Čepelka skalpelová; fig. 20 (baleno po 100 ks)	Scalpel blades fig. 20 (pck=100 pcs)	41
112 91 0021	Čepelka skalpelová; fig. 21 (baleno po 100 ks)	Scalpel blades fig. 21 (pck=100 pcs)	41
112 91 0022	Čepelka skalpelová; fig. 22 (baleno po 100 ks)	Scalpel blades fig. 22 (pck=100 pcs)	41
112 91 0023	Čepelka skalpelová; fig. 23 (baleno po 100 ks)	Scalpel blades fig. 23 (pck=100 pcs)	41
112 91 0024	Čepelka skalpelová; fig. 24 (baleno po 100 ks)	Scalpel blades fig. 24 (pck=100 pcs)	41
112 91 0025	Čepelka skalpelová; fig. 12d (baleno po 100 ks)	Scalpel blades fig. 12d (pck=100 pcs)	41
112 91 0026	Čepelka skalpelová; fig. 15c (baleno po 100 ks)	Scalpel blades fig. 15c (pck=100 pcs)	41
112 91 0027	Čepelka skalpelová; fig. 25 (baleno po 100 ks)	Scalpel blades fig. 25 (pck=100 pcs)	41
113	Nůžky	Scissors	
113 05 0030	Lister nůžky na obvazy; 15,0 cm	Lister bandage scissors; 15,0 cm	53
113 05 0040	Lister nůžky na obvazy; 20,0 cm	Lister bandage scissors; 20,0 cm	53
113 08 0010	Standard nůžky chirurgické rovné; 13,0 cm	Standard operating scissors; 13,0 cm	56
113 08 0020	Standard nůžky chirurgické rovné; 15,0 cm	Standard operating scissors; 15,0 cm	56
113 08 0040	Standard nůžky chirurgické rovné; 18,5 cm	Standard operating scissors; 18,5 cm	56
113 08 0060	Standard nůžky chirurgické rovné; 22,0 cm	Standard operating scissors; 22,0 cm	56
113 08 0070	Standard nůžky chirurgické rovné; 30,0 cm	Standard operating scissors; 30,0 cm	56
113 08 0110	Standard nůžky chirurgické rovné; 13,0 cm	Standard operating scissors; 13,0 cm	56
113 08 0120	Standard nůžky chirurgické rovné; 15,0 cm	Standard operating scissors; 15,0 cm	56
113 08 0140	Standard nůžky chirurgické rovné; 18,5 cm	Standard operating scissors; 18,5 cm	56
113 08 0160	Standard nůžky chirurgické rovné; 22,0 cm	Standard operating scissors; 22,0 cm	56
113 08 0210	Standard nůžky chirurgické rovné; 13,0 cm	Standard operating scissors; 13,0 cm	56
113 08 0220	Standard nůžky chirurgické rovné; 15,0 cm	Standard operating scissors; 15,0 cm	56
113 08 0240	Standard nůžky chirurgické rovné; 18,5 cm	Standard operating scissors; 18,5 cm	56
113 08 0260	Standard nůžky chirurgické rovné; 22,0 cm	Standard operating scissors; 22,0 cm	56
113 08 0310	Standard nůžky chirurgické zahnuté; 13,0 cm	Standard operating scissors; 13,0 cm	56
113 08 0320	Standard nůžky chirurgické zahnuté; 15,0 cm	Standard operating scissors; 15,0 cm	56
113 08 0340	Standard nůžky chirurgické zahnuté; 18,5 cm	Standard operating scissors; 18,5 cm	56
113 08 0360	Standard nůžky chirurgické zahnuté; 22,0 cm	Standard operating scissors; 22,0 cm	56
113 08 0370	Standard nůžky chirurgické zahnuté; 30,0 cm	Standard operating scissors; 30,0 cm	56
113 08 0410	Standard nůžky chirurgické zahnuté; 13,0 cm	Standard operating scissors; 13,0 cm	56
113 08 0420	Standard nůžky chirurgické zahnuté; 15,0 cm	Standard operating scissors; 15,0 cm	56
113 08 0440	Standard nůžky chirurgické zahnuté; 18,5 cm	Standard operating scissors; 18,5 cm	56
113 08 0460	Standard nůžky chirurgické zahnuté; 22,0 cm	Standard operating scissors; 22,0 cm	56
113 08 0510	Standard nůžky chirurgické zahnuté; 13,0 cm	Standard operating scissors; 13,0 cm	56
113 08 0520	Standard nůžky chirurgické zahnuté; 15,0 cm	Standard operating scissors; 15,0 cm	56
113 08 0540	Standard nůžky chirurgické zahnuté; 18,5 cm	Standard operating scissors; 18,5 cm	56
113 08 0560	Standard nůžky chirurgické zahnuté; 22,0 cm	Standard operating scissors; 22,0 cm	56
113 38 0010	Nůžky rovné; 10,0 cm	Scissors straight; 10,0 cm	59
113 38 0020	Nůžky rovné; 10,0 cm	Scissors straight; 10,0 cm	59
113 38 0030	Nůžky rovné; 10,0 cm	Scissors straight; 10,0 cm	59
113 38 0040	Nůžky zahnuté; 10,0 cm	Scissors curved; 10,0 cm	59
113 38 0050	Nůžky zahnuté; 10,0 cm	Scissors curved; 10,0 cm	59
113 38 0060	Nůžky zahnuté; 10,0 cm	Scissors curved; 10,0 cm	59
113 38 0071	Nůžky rovné; 11,5 cm	Scissors straight; 11,5 cm	59

číslo – number	název	item	strana – page
113 38 0081	Nůžky rovné; 11,5 cm	Scissors straight; 11,5 cm	59
113 38 0091	Nůžky zahnuté; 11,5 cm	Scissors curved; 11,5 cm	59
113 38 0100	Nůžky zahnuté; 11,5 cm	Scissors curved; 11,5 cm	59
113 38 0150	Nůžky rovné; 11,5 cm	Scissors straight; 11,5 cm	59
113 38 0161	Nůžky zahnuté; 11,5 cm	Scissors curved; 11,5 cm	59
113 38 0210	Nůžky lomené; 10,5 cm	Scissors angled; 10,5 cm	59
113 38 0260	Nůžky lomené; 10,5 cm	Scissors angled; 10,5 cm	59
113 38 0311	Nůžky; 11,5 cm	Scissors; 11,5 cm	59
113 38 1020	Castroviejo nůžky oční zahnuté; 9,0 cm	Castroviejo eye scissors; 9,0 cm	60
113 38 1030	Castroviejo nůžky oční lomené; 9,0 cm	Castroviejo eye scissors; 9,0 cm	60
113 50 0010	Nůžky na dáseň rovné; 12,0 cm	Gum scissors; 12,0 cm	54
113 50 0020	Nůžky na dáseň zahnuté; 12,0 cm	Gum scissors; 12,0 cm	54
113 50 0030	Nůžky na dáseň rovné; 14,5 cm	Gum scissors; 14,5 cm	54
113 50 0040	Nůžky na dáseň zahnuté; 14,5 cm	Gum scissors; 14,5 cm	54
113 52 0150	Nůžky na korunky rovné; 11,0 cm	Crown scissors; 11,0 cm	112
113 52 0160	Nůžky na korunky zahnuté; 11,0 cm	Crown scissors; 11,0 cm	112
113 91 0002	Standard nůžky chirurgické rovné; 11,5 cm	Standard operating scissors; 11,5 cm	57
113 91 0006	Standard nůžky chirurgické rovné; 16,5 cm	Standard operating scissors; 16,5 cm	57
113 91 0009	Standard nůžky chirurgické rovné; 20,0 cm	Standard operating scissors; 20,0 cm	57
113 91 0011	Standard nůžky chirurgické zahnuté; 11,5 cm	Standard operating scissors; 11,5 cm	57
113 91 0015	Standard nůžky chirurgické zahnuté; 16,5 cm	Standard operating scissors; 16,5 cm	57
113 91 0018	Standard nůžky chirurgické zahnuté; 20,0 cm	Standard operating scissors; 20,0 cm	57
113 91 0020	Nůžky chirurgické rovné; 11,5 cm	Operating scissors; 11,5 cm	57
113 91 0026	Nůžky chirurgické rovné; 16,5 cm	Operating scissors; 16,5 cm	57
113 91 0029	Nůžky chirurgické rovné; 20,0 cm	Operating scissors; 20,0 cm	57
113 91 0031	Nůžky chirurgické zahnuté; 11,5 cm	Operating scissors; 11,5 cm	57
113 91 0037	Nůžky chirurgické zahnuté; 16,5 cm	Operating scissors; 16,5 cm	57
113 91 0040	Nůžky chirurgické zahnuté; 20,0 cm	Operating scissors; 20,0 cm	57
113 91 0042	Nůžky chirurgické rovné; 11,5 cm	Operating scissors; 11,5 cm	57
113 91 0046	Nůžky chirurgické rovné; 16,5 cm	Operating scissors; 16,5 cm	57
113 91 0049	Nůžky chirurgické rovné; 20,0 cm	Operating scissors; 20,0 cm	57
113 91 0051	Nůžky chirurgické zahnuté; 11,5 cm	Operating scissors; 11,5 cm	57
113 91 0055	Nůžky chirurgické zahnuté; 16,5 cm	Operating scissors; 16,5 cm	57
113 91 0058	Nůžky chirurgické zahnuté; 20,0 cm	Operating scissors; 20,0 cm	57
113 91 0221	Sanvenero nůžky preparační hrotnaté rovné; 14,0 cm	Sanvenero dissecting scissors; 14,0 cm	55
113 91 0222	Sanvenero nůžky preparační hrotnaté zahnuté; 14,0 cm	Sanvenero dissecting scissors; 14,0 cm	55
113 91 0233	Reynolds nůžky preparační ostré rovné; 15,0 cm	Reynolds dissecting scissors; 15,0 cm	55
113 91 0235	Reynolds nůžky preparační ostré zahnuté; 15,0 cm	Reynolds dissecting scissors; 15,0 cm	55
113 91 0328	Wagner nůžky jemné hrotnaté rovné; 12,0 cm	Wagner fine scissors straight; 12,0 cm	58
113 91 0331	Wagner nůžky jemné hrotnaté zahnuté; 12,0 cm	Wagner fine scissors curved; 12,0 cm	58
113 91 0348	Walton nůžky jemné hrotnaté zahnuté; 10,0 cm	Walton fine scissors sharp curved; 10,0 cm	58
113 91 0349	Mod. Bonn nůžky extra jemné rovné; 8,0 cm	Mod. Bonn extra delicate scissors straight; 8,0 cm	58
113 91 0350	Mod. Bonn nůžky extra jemné zahnuté; 8,0 cm	Mod. Bonn extra delicate scissors curved; 8,0 cm	58
113 91 0399	Spencer nůžky pro ligaturu; 9 cm	Spencer ligature scissors; 9,0 cm	55
113 91 0400	Spencer nůžky pro ligaturu; 10,5 cm	Spencer ligature scissors; 10,5 cm	55
113 91 0403	Littauer nůžky pro ligaturu; 14,0 cm	Littauer ligature scissors; 14,0 cm	55
113 91 0474	Goldman-Fox nůžky na dáseň rovné; 13,0 cm	Goldman-Fox scissors; 13,0 cm	54
113 91 0475	Goldman-Fox nůžky na dáseň zahnuté; 13,0 cm	Goldman-Fox scissors; 13,0 cm	54
113 91 0483	Quinby nůžky na dáseň rovné; 12,0 cm	Quinby gum scissors; 12,0 cm	54
113 91 0484	Quinby nůžky na dáseň zahnuté; 12,0 cm	Quinby gum scissors; 12,0 cm	54
113 91 0490	Noyes nůžky na duhovku hrotnaté rovné; 12,0 cm	Noyes iris scissors; 12,0 cm	60
113 91 0492	Noyes nůžky na duhovku hrotnatotupé rovné; 12,0 cm	Noyes iris scissors; 12,0 cm	60
113 91 0494	Noyes nůžky na duhovku tupé rovné; 12,0 cm	Noyes iris scissors; 12,0 cm	60
113 91 0502	Castroviejo nůžky na duhovku ostré rovné; 9,0 cm	Castroviejo iris scissors; 9,0 cm	60
113 91 0503	Castroviejo nůžky na duhovku tupé rovné; 9,0 cm	Castroviejo iris scissors; 9,0 cm	60
113 91 0505	Castroviejo nůžky na duhovku tupé lomené; 9,0 cm	Castroviejo iris scissors; 9,0 cm	60
113 91 0507	Castroviejo nůžky na duhovku hrotnaté; 10,0 cm	Castroviejo iris scissors; 10,0 cm	60
113 91 0508	Castroviejo nůžky na duhovku tupé; 10,0 cm	Castroviejo iris scissors; 10,0 cm	60
113 91 0537	Gomel nůžky mikro tupé; 14,5 cm	Gomel dissection micro scissors; 14,5 cm	61
113 91 0538	Gomel nůžky mikro tupé; 18,0 cm	Gomel dissection micro scissors; 18,0 cm	61
113 91 0539	Gomel nůžky mikro hrotnaté; 14,5 cm	Gomel dissection micro scissors; 14,5 cm	61
113 91 0540	Gomel nůžky mikro hrotnaté; 18,0 cm	Gomel dissection micro scissors; 18,0 cm	61
113 91 0552	Nůžky mikro; rovné 18,5 cm	Dissection micro scissors; straight 18,5 cm	61
113 91 0553	Nůžky mikro; zahnuté 18,5 cm	Dissection micro scissors; curved 18,5 cm	61
114	Pinzety	Forceps	
114 08 0030	Standard pinzeta anatomická; 16,0 cm	Dressing forceps; 16,0 cm	64
114 08 0040	Standard pinzeta anatomická; 20,0 cm	Dressing forceps; 20,0 cm	64
114 08 0050	Standard pinzeta anatomická; 25,0 cm	Dressing forceps; 25,0 cm	64
114 08 0060	Standard pinzeta anatomická; 30,0 cm	Dressing forceps; 30,0 cm	64

číslo – number	název	item	strana – page
114 08 0090	Pinzeta anatomická rovná jemná; 14,5 cm	Dressing forceps; 14,5 cm	63
114 08 0101	Pinzeta anatomická jemná; 14,5 cm	Dressing forceps; 14,5 cm	63
114 08 0140	Pinzeta anatomická jemná; 20,0 cm	Dressing forceps; 20,0 cm	63
114 08 0231	Pinzeta anatomická velmi jemná; 14,5 cm	Dressing forceps; 14,5 cm	63
114 08 0240	Pinzeta anatomická velmi jemná; 20,0 cm	Dressing forceps; 20,0 cm	63
114 08 0250	Pinzeta anatomická velmi jemná; 24,5 cm	Dressing forceps; 24,5 cm	63
114 08 0340	Standard pinzeta chirurgická; 20,0 cm	Tissue forceps; 20,0 cm	64
114 08 0350	Standard pinzeta chirurgická; 25,0 cm	Tissue forceps; 25,0 cm	64
114 08 0360	Standard pinzeta chirurgická; 30,0 cm	Tissue forceps; 30,0 cm	64
114 08 0381	Standard pinzeta chirurgická; 14,5 cm	Tissue forceps; 14,5 cm	64
114 08 0430	Standard pinzeta chirurgická jemná; 16,0 cm	Tissue forceps; 16,0 cm	65
114 08 0530	Pinzeta chirurgická velmi jemná; 1×2 zuby; 14,5 cm	Tissue forceps; 1×2 teeth; 14,5 cm	65
114 14 0100	Pinzeta cévní atraumatická rovná; 2,0 mm; 14,5 cm	Non-traumatic forceps; 2,0 mm; 14,5 cm	67
114 14 0300	Pinzeta cévní atraumatická rovná jemná; 14,5 cm	Non-traumatic forceps; 14,5 cm	67
114 38 0010	Graefe pinzeta oční rovná; 10,5 cm	Graefe eye forceps; 10,5 cm	68
114 38 0020	Graefe pinzeta oční rovná jemná; 10,5 cm	Graefe eye forceps; 10,5 cm	68
114 38 0100	Graefe pinzeta oční zahnutá jemná; 10,5 cm	Graefe eye forceps; 10,5 cm	68
114 38 0150	Graefe pinzeta oční rovná; 1×2 zuby; 10,5 cm	Graefe eye forceps; 1×2 teeth; 10,5 cm	68
114 38 0160	Graefe pinzeta oční rovná jemná; 1×2 zuby; 10,5 cm	Graefe eye forceps; 1×2 teeth; 10,5 cm	68
114 38 0360	Graefe pinzeta fixační s uzávěrem s perem; 11,0 cm	Graefe fixation forceps; 11,0 cm	68
114 50 0011	Pinzeta zubní s rýhovanou čelistí zahnutá; 15,7 cm	Dental forceps curved; 15,7 cm	62
114 50 0021	Pinzeta zubní s rýhovanou čelistí lomená; 15,7 cm	Dental forceps angled; 15,7 cm	62
114 50 0031	Pinzeta zubní s hladkou čelistí lomená; 15,7 cm	Dental forceps angled; 15,7 cm	62
114 50 0051	Pinzeta na kořenové čípky; 15,7 cm	Root suppository forceps; 15,7 cm	62
114 50 0150	Pinzeta zubní chirurgická zahnutá jemná; 14,2 cm	Dental forceps; 14,2 cm	62
114 50 0170	Pinzeta zubní chirurgická zahnutá; 15,7 cm	Dental forceps; 15,7 cm	62
114 50 1030	Pinzeta zubní lomená Dia; 15,7 cm	Dental forceps Dia; 15,7 cm	62
114 52 0030	Pinzeta laboratorní; 0,3 mm; 12,5 cm	Laboratory forceps; 0,3 mm; 12,5 cm	111
114 52 0050	Pinzeta laboratorní; 0,3 mm; 11,0 cm	Laboratory forceps; 0,3 mm; 11,0 cm	111
114 91 0002	Standard pinzeta chirurgická; 11,5 cm	Tissue forceps; 11,5 cm	64
114 91 0003	Standard pinzeta chirurgická; 13,0 cm	Tissue forceps; 13,0 cm	64
114 91 0004	Standard pinzeta chirurgická; 14,5 cm	Tissue forceps; 14,5 cm	64
114 91 0006	Standard pinzeta chirurgická; 18,0 cm	Tissue forceps; 18,0 cm	64
114 91 0011	Standard pinzeta chirurgická; 11,5 cm	Tissue forceps; 11,5 cm	64
114 91 0012	Standard pinzeta chirurgická; 13,0 cm	Tissue forceps; 13,0 cm	64
114 91 0015	Standard pinzeta chirurgická; 18,0 cm	Tissue forceps; 18,0 cm	64
114 91 0255	Pinzeta šicí rovná; 0,3 mm; 12,0 cm	Suture tying forceps; 0,3 mm; 12,0 cm	65
114 91 0256	Pinzeta šicí rovná; 0,3 mm; 15,0 cm	Suture tying forceps; 0,3 mm; 15,0 cm	65
114 91 0257	Pinzeta šicí zahnutá; 0,3 mm; 12,0 cm	Suture tying forceps; 0,3 mm; 12,0 cm	65
114 91 0258	Pinzeta šicí zahnutá; 0,3 mm; 15,0 cm	Suture tying forceps; 0,3 mm; 15,0 cm	65
114 91 0451	De Bakey pinzeta atraumatická rovná; 1,5 mm; 16,0 cm	De Bakey atrauma forceps; 1,5 mm; 16,0 cm	67
114 91 0453	De Bakey pinzeta atraumatická rovná; 1,5 mm; 20,0 cm	De Bakey atrauma forceps; 1,5 mm; 20,0 cm	67
114 91 0454	De Bakey pinzeta atraumatická rovná; 1,5 mm; 24,0 cm	De Bakey atrauma forceps; 1,5 mm; 24,0 cm	67
114 91 0455	De Bakey pinzeta atraumatická rovná; 2,0 mm; 16,0 cm	De Bakey atrauma forceps; 2,0 mm; 16,0 cm	67
114 91 0457	De Bakey pinzeta atraumatická rovná; 2,0 mm; 20,0 cm	De Bakey atrauma forceps; 2,0 mm; 20,0 cm	67
114 91 0458	De Bakey pinzeta atraumatická rovná; 2,0 mm; 24,0 cm	De Bakey atrauma forceps; 2,0 mm; 24,0 cm	67
114 91 0467	De Bakey pinzeta atraumatická zahnutá; 2,0 mm; 16,0 cm	De Bakey atrauma forceps; 2,0 mm; 16,0 cm	67
114 91 0469	De Bakey pinzeta atraumatická zahnutá; 2,0 mm; 20,0 cm	De Bakey atrauma forceps; 2,0 mm; 20,0 cm	67
114 91 0470	De Bakey pinzeta atraumatická zahnutá; 2,0 mm; 24,0 cm	De Bakey atrauma forceps; 2,0 mm; 24,0 cm	67
114 91 0477	Oehler pinzeta chirurgická tvrdokov; 1×2 zuby; 14,0 cm	Oehler tissue forceps TUC; 1×2 teeth; 14,0 cm	66
114 91 0478	Oehler pinzeta chirurgická tvrdokov; 1×2 zuby; 16,0 cm	Oehler tissue forceps TUC; 1×2 teeth; 16,0 cm	66
114 91 0479	Oehler pinzeta chirurgická tvrdokov; 1×2 zuby; 18,0 cm	Oehler tissue forceps TUC; 1×2 teeth; 18,0 cm	66
114 91 0480	Oehler pinzeta chirurgická tvrdokov; 1×2 zuby; 20,0 cm	Oehler tissue forceps TUC; 1×2 teeth; 20,0 cm	66
114 91 0481	Oehler pinzeta chirurgická tvrdokov; 1×2 zuby; 25,0 cm	Oehler tissue forceps TUC; 1×2 teeth; 25,0 cm	66
114 91 0482	Oehler pinzeta chirurgická tvrdokov; 1×2 zuby; 30,0 cm	Oehler tissue forceps TUC; 1×2 teeth; 30,0 cm	66
114 91 0483	Semken pinzeta anatomická tvrdokov; 12,5 cm	Semken dissecting forceps TUC; 12,5 cm	66
114 91 0484	Semken pinzeta anatomická tvrdokov; 15,5 cm	Semken dissecting forceps TUC; 15,5 cm	66
114 91 0485	Gillies pinzeta chirurgická tvrdokov; 1×2 zuby; 15,0 cm	Gillies tissue forceps TUC; 1×2 teeth; 15,0 cm	66
114 91 0486	Jeweler pinzeta tvrdokov; 15,0 cm	Jeweler forceps TUC; 15,0 cm	66
114 91 0487	Adson pinzeta anatomická tvrdokov; 12,0 cm	Adson forceps TUC; 12,0 cm	66
114 91 0489	Adson pinzeta anatomická tvrdokov; 15,0 cm	Adson forceps TUC; 15,0 cm	66
114 91 0490	Adson pinzeta chirurgická tvrdokov; 1×2 zuby; 12,0 cm	Adson forceps TUC; 1×2 teeth; 12,0 cm	66
114 91 0491	Adson pinzeta chirurgická tvrdokov; 1×2 zuby; 15,0 cm	Adson forceps TUC; 1×2 teeth; 15,0 cm	66
115	Svorky	Clamps, Forceps	
115 08 0010	Mosquito-Halsted svorka na cévy rovná; 12,0 cm	Mosquito-Halsted artery forceps; 12,0 cm	42
115 08 0020	Mosquito-Halsted svorka na cévy zahnutá; 12,0 cm	Mosquito-Halsted artery forceps; 12,0 cm	42
115 08 0030	Mosquito-Halsted svorka na cévy rovná; 12,0 cm	Mosquito-Halsted artery forceps; 12,0 cm	42
115 08 0040	Mosquito-Halsted svorka na cévy rovná; 12,0 cm	Mosquito-Halsted artery forceps; 12,0 cm	42
115 08 0050	Mosquito-Halsted svorka na cévy zahnutá; 12,0 cm	Mosquito-Halsted artery forceps; 12,0 cm	42

číslo – number	název	item	strana – page
115 08 0060	Mosquito-Halsted svorka na cévy zahnutá; 12,0 cm	Mosquito-Halsted artery forceps; 12,0 cm	42
115 08 0780	Backhaus svorka na prádlo; 11,8 cm	Backhaus towel forceps; 11,8 cm	46
115 08 0790	Backhaus svorka na prádlo; 12,0 cm	Backhaus towel forceps; 12,0 cm	46
115 08 0810	Backhaus svorka na prádlo; 8,0 cm	Backhaus towel forceps; 8,0 cm	46
115 08 0820	Backhaus svorka na prádlo; 13,0 cm	Backhaus towel forceps; 13,0 cm	46
115 08 1010	Mosquito-Halsted svorka na cévy rovná; 12,0 cm	Mosquito-Halsted artery forceps; 12,0 cm	42
115 08 1020	Mosquito-Halsted svorka na cévy zahnutá; 12,0 cm	Mosquito-Halsted artery forceps; 12,0 cm	42
115 08 1030	Mosquito-Halsted svorka na cévy rovná; 12,0 cm	Mosquito-Halsted artery forceps; 12,0 cm	42
115 08 1050	Mosquito-Halsted svorka na cévy zahnutá; 12,0 cm	Mosquito-Halsted artery forceps; 12,0 cm	42
115 91 0068	Hartmann svorka rovná; 10,0 cm	Hartmann forceps; 10,0 cm	43
115 91 0069	Hartmann svorka zahnutá; 10,0 cm	Hartmann forceps; 10,0 cm	43
115 91 0073	Micro-Mosquito svorka na cévy rovná; 12,0 cm	Micro-Mosquito artery forceps; 12,0 cm	43
115 91 0075	Micro-Mosquito svorka na cévy zahnutá; 12,0 cm	Micro-Mosquito artery forceps; 12,0 cm	43
115 91 0077	Micro-Mosquito svorka rovná 1×2 zuby; 12,0 cm	Micro-Mosquito artery forceps; 1×2 teeth; 12,0 cm	43
115 91 0079	Micro-Mosquito svorka zahnutá 1×2 zuby; 12,0 cm	Micro-Mosquito artery forceps; 1×2 teeth; 12,0 cm	43
115 91 0080	Halsted-Mosquito svorka na cévy rovná; 12,5 cm	Halsted-Mosquito artery forceps straight; 12,5 cm	43
115 91 0082	Halsted-Mosquito svorka na cévy zahnutá; 12,5 cm	Halsted-Mosquito artery forceps curved; 12,5 cm	43
115 91 0084	Halsted-Mosquito svorka; 1×2 zuby rovná; 12,5 cm	Halsted-Mosquito artery forceps straight; 1×2 teeth; 12,5 cm	43
115 91 0086	Halsted-Mosquito svorka zahnutá; 1×2 zuby; 12,5 cm	Halsted-Mosquito artery forceps curved; 1×2 teeth; 12,5 cm	43
115 91 0341	Backhaus-Clip svorka na prádlo; 11,0 cm	Backhaus-Clip towel forceps; 11,0 cm	46
115 91 0343	Backhaus svorka na prádlo; 11,0 cm	Backhaus towel forceps; 11,0 cm	46
115 91 0345	Backhaus svorka na prádlo; 15,0 cm	Backhaus towel forceps; 15,0 cm	46
115 91 0348	Roeder svorka na prádlo; 13,0 cm	Roeder towel forceps; 13,0 cm	47
115 91 0349	Roeder svorka na prádlo; 15,0 cm	Roeder towel forceps; 15,0 cm	47
115 91 0350	Lorna svorka na prádlo; 10,0 cm	Lorna towel forceps; 10,0 cm	47
115 91 0351	Lorna svorka na prádlo; 13,0 cm	Lorna towel forceps; 13,0 cm	47
115 91 0352	Tohoku-Japan svorka na prádlo; 10,0 cm	Tohoku-Japan towel forceps; 10,0 cm	47
115 91 0353	Tohoku-Japan svorka na prádlo; 13,0 cm	Tohoku-Japan towel forceps; 13,0 cm	47
115 91 0354	Peers svorka na prádlo; 10,0 cm	Peers towel forceps; 10,0 cm	47
115 91 0382	Babcock svorka chirurgická; 16,0 cm	Babcock tissue seizing forceps; 16,0 cm	44
115 91 0591	De Bakey-Pean svorka atraumatická; 14,0 cm	De Bakey-Pean atrauma forceps; 14,0 cm	45
115 91 0592	De Bakey-Pean svorka atraumatická; 14,0 cm	De Bakey-Pean atrauma forceps; 14,0 cm	45
115 91 0596	De Bakey-Mosquito svorka atraumatická; 12,0 cm	De Bakey-Mosquito atrauma forceps; 12,0 cm	45
115 91 0625	De Bakey-Rankin svorka atraumatická; 16,0 cm	De Bakey-Rankin atrauma forceps; 16,0 cm	45
115 91 0626	De Bakey-Rankin svorka atraumatická; 16,0 cm	De Bakey-Rankin atrauma forceps; 16,0 cm	45
115 91 0627	De Bakey-Mosquito svorka atraumatická; 15,0 cm	De Bakey-Mosquito atrauma forceps; 15,0 cm	45
115 91 0628	De Bakey-Mosquito svorka atraumatická; 15,0 cm	De Bakey-Mosquito atrauma forceps; 15,0 cm	45
115 91 0629	De Bakey-Mosquito svorka atraumatická; 12,0 cm	De Bakey-Mosquito atrauma forceps; 12,0 cm	45
115 91 0630	De Bakey-Pean svorka atraumatická; 16,0 cm	De Bakey-Pean atrauma forceps; 16,0 cm	45
115 91 0632	De Bakey-Pean svorka atraumatická; 16,0 cm	De Bakey-Pean atrauma forceps; 16,0 cm	45
116	Kleště štípací	Bone Rongeurs	
116 08 0030	Luer kleště štípací na kosti rovné; 17,0 cm	Luer bone rongeurs; 17,0 cm	17
116 08 0070	Luer kleště štípací na kosti silně zah.; 15,0 cm	Luer bone rongeurs; 15,0 cm	17
116 08 0080	Luer kleště štípací na kosti zahnuté; 14,5 cm	Luer bone rongeurs; 14,5 cm	17
116 08 0410	Liston kleště štípací rovné; 14,0 cm	Liston bone rongeurs; 14,0 cm	18
116 08 0440	Liston kleště štípací rovné; 19,0 cm	Liston bone rongeurs; 19,0 cm	18
116 08 0450	Liston kleště štípací zahnuté; 19,0 cm	Liston bone rongeurs; 19,0 cm	18
116 29 0410	Jansen kleště štípací fig. 2; 18,0 cm	Jansen mastoid forceps fig. 2; 18,0 cm	17
116 91 0001	Kleště štípací na drát; 14,5 cm	Wire cutting forceps; 14,5 cm	113
116 91 0005	Kleště štípací na drát; 17,0 cm	Wire cutting forceps; 17,0 cm	113
116 91 0017	Mini-Friedman kleště štípací na kosti; 12,0 cm	Mini-Friedman bone ronguers; 12,0 cm	16
116 91 0514	Friedman kleště štípací na kosti; 14,0 cm	Friedman bone ronguers; 14,0 cm	16
116 91 0515	Stellbrink kleště štípací na kosti; 17,0 cm	Stellbrink bone ronguers; 17,0 cm	16
116 91 0516	Stellbrink kleště štípací na kosti; 17,0 cm	Stellbrink bone ronguers; 17,0 cm	16
116 91 0518	Cleveland kleště štípací na kosti; 17,0 cm	Cleveland bone ronguers; 17,0 cm	16
116 91 0522	Blumenthal kleště štípací na kosti; 15,5 cm	Blumenthal bone ronguers; 15,5 cm	16
116 91 0523	Blumenthal kleště štípací na kosti; 15,5 cm	Blumenthal bone ronguers; 15,5 cm	16
116 91 0524	Blumenthal kleště štípací na kosti; 15,5 cm	Blumenthal bone ronguers; 15,5 cm	16
116 91 0527	Luer kleště štípací na kosti; 15,0 cm	Luer bone ronguers; 15,0 cm	16
116 91 0528	Luer kleště štípací na kosti; 15,0 cm	Luer bone ronguers; 15,0 cm	16
116 91 0529	Luer kleště štípací na kosti; 15,0 cm	Luer bone ronguers; 15,0 cm	16
117	Kleště úchopné, extrakční	Grasping Forceps, Extraction Forceps	
117 31 0010	Collin kleště na jazyk okénkované; 16,7 cm	Collin tongue holding forceps; 16,7 cm	19
117 31 0030	Löbker kleště na jazyk jednoháčkové; 15,0 cm	Löbker tongue holding forceps; 15,0 cm	19
117 50 0010	Kleště extrakční D2	Extraction forceps D2	11
117 50 0020	Kleště extrakční D7	Extraction forceps D7	11
117 50 0030	Kleště extrakční D17	Extraction forceps D17	11
117 50 0040	Kleště extrakční D18	Extraction forceps D18	11
117 50 0050	Kleště extrakční D67	Extraction forceps D67	13

číslo – number	název	item	strana – page
117 50 0060	Kleště extrakční D30S	Extraction forceps D30S	13
117 50 0150	Kleště extrakční D13	Extraction forceps D13	12
117 50 0160	Kleště extrakční D22	Extraction forceps D22	12
117 50 0170	Kleště extrakční D73	Extraction forceps D73	14
117 50 0180	Kleště extrakční D79	Extraction forceps D79	14
117 50 0190	Kleště extrakční D33A	Extraction forceps D33a	12
117 50 0200	Kleště extrakční D33	Extraction forceps D33	12
117 50 0250	Kleště extrakční D51A	Extraction forceps D51A	13
117 50 0260	Kleště extrakční D51	Extraction forceps D51	13
117 50 0300	Kleště extrakční D342	Extraction forceps D342	15
117 50 0310	Kleště extrakční D339	Extraction forceps D339	15
117 50 0330	Kleště extrakční D74N	Extraction forceps D74N	14
117 50 0340	Kleště extrakční D74M	Extraction forceps D74M	14
117 50 0350	Kleště extrakční D74	Extraction forceps D74	14
117 50 1010	Kleště extrakční D2 diamantované	Extraction forceps D2 diamond	11
117 50 1020	Kleště extrakční D7 diamantované	Extraction forceps D7 diamond	11
117 50 1030	Kleště extrakční D17 diamantované	Extraction forceps D17 diamond	11
117 50 1040	Kleště extrakční D18 diamantované	Extraction forceps D18 diamond	11
117 50 1050	Kleště extrakční D67 diamantované	Extraction forceps D67 diamond	13
117 50 1060	Kleště extrakční D30S diamantované	Extraction forceps D30S diamond	13
117 50 1150	Kleště extrakční D13 diamantované	Extraction forceps D13 diamond	12
117 50 1160	Kleště extrakční D22 diamantované	Extraction forceps D22 diamond	12
117 50 1170	Kleště extrakční D73 diamantované	Extraction forceps D73 diamond	14
117 50 1180	Kleště extrakční D79 diamantované	Extraction forceps D79 diamond	14
117 50 1190	Kleště extrakční D33A diamantované	Extraction forceps D33A diamond	12
117 50 1200	Kleště extrakční D33 diamantované	Extraction forceps D33 diamond	12
117 50 1250	Kleště extrakční D51A diamantované	Extraction forceps D51A diamond	13
117 50 1260	Kleště extrakční D51 diamantované	Extraction forceps D5 diamond	13
117 50 1300	Kleště extrakční D342 diamantované	Extraction forceps D342 diamond	15
117 50 1310	Kleště extrakční D339 diamantované	Extraction forceps D339 diamond	15
117 50 1330	Kleště extrakční D74N diamantované	Extraction forceps D74N diamond	14
117 50 1340	Kleště extrakční D74M diamantované	Extraction forceps D74M diamond	14
117 50 1350	Kleště extrakční D74 diamantované	Extraction forceps D74 diamond	14
117 51 0600	Kleště k odstranění kořen.nástrojů rovné; 13,5 cm	Forceps for extraction of root instruments; 13,5 cm	15
117 51 0610	Kleště k odstranění kořen.nástrojů zahnuté; 13,5 cm	Forceps for extraction of root instruments; 13,5 cm	15
117 51 1600	Kleště k odstranění kořen.nástrojů rovné Dia; 13,5 cm	Forceps for extraction of root instruments straight Dia; 13,5 cm	15
117 51 1610	Kleště k odstranění kořen.nástrojů zahnuté Dia; 13,3 cm	Forceps for extraction of root instruments curved Dia; 13,3 cm	15
117 52 0700	Kleště laboratorní fig. 1; 13,5 cm	Laboratory forceps fig. 1; 13,5 cm	113
117 52 0770	Kleště na kelímky; 50,0 cm	Crucible forceps; 50,0 cm	113
117 52 0780	Kleště na kelímky; 27,5 cm	Crucible forceps; 27,5 cm	113
117 91 0001	Lister kleště tamponové; 13,0 cm	Lister sinus forceps; 13,0 cm	19
117 91 0002	Lister kleště tamponové; 16,0 cm	Lister sinus forceps; 16,0 cm	19
117 91 0003	Lister kleště tamponové; 18,0 cm	Lister sinus forceps; 18,0 cm	19
117 91 0033	Collin kleště tamponové; 24,0 cm	Collin dressing forceps; 24,0 cm	19
117 91 0038	Heywood-Smith kleště tamponové; 21,0 cm	Heywood-Smith sponge holding forceps; 21,0 cm	19
117 91 0039	Heywood-Smith kleště tamponové; 25,0 cm	Heywood-Smith sponge holding forceps; 25,0 cm	19
118	Háčky	Hooks, Retractors	
118 08 0010	Háček na rány jednozubý ostrý; 16,0 cm	Delicate hook one-pronged sharp; 16,0 cm	30
118 08 0020	Háček na rány dvouzubý ostrý; 16,0 cm	Delicate hook two-pronged sharp; 16,0 cm	30
118 08 0050	Háček na rány jednozubý tupý; 16,0 cm	Delicate hook one-pronged blunt; 16,0 cm	30
118 08 0060	Háček na rány dvouzubý tupý; 16,0 cm	Delicate hook two-pronged blunt; 16,0 cm	30
118 08 0650	Middeldorpf hák na rány okénk.; 14×12 mm; 22,0 cm	Middeldorpf retractor; 14×12 mm; 22,0 cm	33
118 08 0660	Middeldorpf hák na rány okénk.; 21×21 mm; 22,0 cm	Middeldorpf retractor; 21×21 mm; 22,0 cm	33
118 08 0670	Middeldorpf hák na rány okénk.; 32×31 mm; 23,5 cm	Middeldorpf retractor; 32×31 mm; 23,5 cm	33
118 08 0680	Middeldorpf hák na rány okénk.; 62×50 mm; 28,0 cm	Middeldorpf retractor; 62×50 mm; 28,0 cm	33
118 08 0800	Langenbeck hák na rány; 40×10 mm; 21,0 cm	Langenbeck retractor; 40×10 mm; 21,0 cm	34
118 08 0810	Langenbeck hák na rány; 42×13 mm; 21,0 cm	Langenbeck retractor; 42×13 mm; 21,0 cm	34
118 12 0010	Háček pro plastiku jednozubý ostrý fig. 1; 16,0 cm	Plastic hook one-pronged sharp; fig. 1; 16,0 cm	32
118 12 0020	Háček pro plastiku jednozubý ostrý fig. 2; 16,0 cm	Plastic hook one-pronged sharp; fig. 2; 16,0 cm	32
118 12 0050	Háček pro plastiku dvouzubý tupý; 5,0 mm; 16,0 cm	Plastic hook 2 prongs blunt; 5,0 mm; 16,0 cm	32
118 12 0060	Háček pro plastiku dvouzubý ostrý; 5,0 mm; 16,0 cm	Plastic hook 2 prongs sharp; 5,0 mm; 16,0 cm	32
118 31 0040	Hák resekcí čtyřzubý rovný; 16,4 cm	Resection hook four-pronged straight; 16,4 cm	34
118 38 0010	Desmarres háček jemný; 10,0 mm; 13,0 cm	Desmarres delicate hook; 10,0 mm; 13,0 cm	31
118 38 0020	Desmarres háček jemný; 12,0 mm; 13,0 cm	Desmarres delicate hook; 12,0 mm; 13,0 cm	31
118 38 0030	Desmarres háček jemný; 14,0 mm; 13,0 cm	Desmarres delicate hook; 14,0 mm; 13,0 cm	31
118 38 0210	Háček oční dvouzubý ostrý; 2,6 mm; 13,5 cm	Eye hook two-pronged sharp; 2,6 mm; 13,5 cm	32
118 38 0220	Háček oční dvouzubý ostrý; 3,2 mm; 13,5 cm	Eye hook two-pronged sharp; 3,2 mm; 13,5 cm	32
118 38 0230	Háček oční dvouzubý ostrý; 4,0 mm; 13,5 cm	Eye hook two-pronged sharp; 4,0 mm; 13,5 cm	32
118 38 0360	Háček oční čtyřzubý ostrý; 5,0 mm; 14,5 cm	Eye hook four-pronged sharp; 5,0 mm; 14,5 cm	32

číslo – number	název	item	strana – page
118 50 0120	Hák intraorální; 22,9 cm	Intraolar hook; 22,9 cm	35
118 91 0027	Háček na rány trojzubý ostrý; 16,0 cm	Delicate hook three-pronged sharp; 16,0 cm	30
118 91 0028	Háček na rány čtyřzubý ostrý; 16,0 cm	Delicate hook four-pronged sharp; 16,0 cm	30
118 91 0035	Háček na rány trojzubý tupý; 16,0 cm	Delicate hook three-pronged blunt; 16,0 cm	30
118 91 0036	Háček na rány čtyřzubý tupý; 16,0 cm	Delicate hook four-pronged blunt; 16,0 cm	30
118 91 0045	Háček na rány dvouzubý ostrý; 16,0 cm	Delicate hook two-pronged sharp; 16,0 cm	30
118 91 0046	Háček na rány trojzubý ostrý; 16,0 cm	Delicate hook three-pronged sharp; 16,0 cm	30
118 91 0047	Háček na rány čtyřzubý ostrý; 16,0 cm	Delicate hook four-pronged sharp; 16,0 cm	30
118 91 0048	Háček na rány dvouzubý tupý; 16,0 cm	Delicate hook two-pronged blunt; 16,0 cm	30
118 91 0049	Háček na rány trojzubý tupý; 16,0 cm	Delicate hook three-pronged blunt; 16,0 cm	30
118 91 0050	Háček na rány čtyřzubý tupý; 16,0 cm	Delicate hook four-pronged blunt; 16,0 cm	30
118 91 0051	Joseph háček na rány jednozubý ostrý; 16,0 cm	Joseph delicate hook one-pronged sharp; 16,0 cm	30
118 91 0052	Joseph háček na rány dvouzubý ostrý, 2,0 mm; 16,0 cm	Joseph delicate hook two-pronged sharp; 16,0 cm	30
118 91 0053	Joseph háček na rány dvouzubý ostrý, 5,0 mm; 16,0 cm	Joseph delicate hook two-pronged sharp; 16,0 cm	30
118 91 0054	Joseph háček na rány dvouzubý ostrý, 7,0 mm; 16,0 cm	Joseph delicate hook two-pronged sharp; 16,0 cm	30
118 91 0055	Joseph háček na rány dvouzubý ostrý, 10,0 mm; 16,0 cm	Joseph delicate hook two-pronged sharp; 16,0 cm	30
118 91 0069	Mini-Langenbeck háček jemný; 16,0 cm	Mini-Langenbeck delicate hook; 16,0 cm	31
118 91 0070	Mini-Langenbeck háček jemný; 16,0 cm	Mini-Langenbeck delicate hook; 16,0 cm	31
118 91 0071	Mini-Langenbeck háček jemný; 16,0 cm	Mini-Langenbeck delicate hook; 16,0 cm	31
118 91 0072	Mini-Langenbeck háček jemný; 16,0 cm	Mini-Langenbeck delicate hook; 16,0 cm	31
118 91 0077	Desmarres háček jemný; 16,0 mm; 13,0 cm	Desmarres delicate hook; 16,0 mm; 13,0 cm	31
118 91 0078	Desmarres háček jemný; 18,0 mm; 13,0 cm	Desmarres delicate hook; 18,0 mm; 13,0 cm	31
118 91 0085	Cushing háček jemný; 8,0 mm; 20,0 cm	Cushing delicate hook; 8,0 mm; 20,0 cm	31
118 91 0086	Cushing háček jemný; 10,0 mm; 20,0 cm	Cushing delicate hook; 10,0 mm; 20,0 cm	31
118 91 0087	Cushing háček jemný; 12,0 mm; 20,0 cm	Cushing delicate hook; 12,0 mm; 20,0 cm	31
118 91 0088	Cushing háček jemný; 14,0 mm; 20,0 cm	Cushing delicate hook; 14,0 mm; 20,0 cm	31
118 91 0089	Cushing háček jemný; 16,0 mm; 20,0 cm	Cushing delicate hook; 16,0 mm; 20,0 cm	31
118 91 0090	Cushing háček jemný; 18,0 mm; 20,0 cm	Cushing delicate hook; 18,0 mm; 20,0 cm	31
118 91 0091	Cushing háček jemný; 8,0 mm; 24,0 cm	Cushing delicate hook; 8,0 mm; 24,0 cm	31
118 91 0092	Cushing háček jemný; 10,0 mm; 24,0 cm	Cushing delicate hook; 10,0 mm; 24,0 cm	31
118 91 0093	Cushing háček jemný; 12,0 mm; 24,0 cm	Cushing delicate hook; 12,0 mm; 24,0 cm	31
118 91 0094	Cushing háček jemný; 14,0 mm; 24,0 cm	Cushing delicate hook; 14,0 mm; 24,0 cm	31
118 91 0095	Cushing háček jemný; 16,0 mm; 24,0 cm	Cushing delicate hook; 16,0 mm; 24,0 cm	31
118 91 0096	Cushing háček jemný; 18,0 mm; 24,0 cm	Cushing delicate hook; 18,0 mm; 24,0 cm	31
118 91 0208	Middeldorpf hák na rány okénk.; 14×17 mm; 21,5 cm	Middeldorpf retractor; 14×17 mm; 21,5 cm	33
118 91 0209	Middeldorpf hák na rány okénk.; 20×22 mm; 22,0 cm	Middeldorpf retractor; 20×22 mm; 22,0 cm	33
118 91 0210	Middeldorpf hák na rány okénk.; 26×30 mm; 23,5 cm	Middeldorpf retractor; 26×30 mm; 23,5 cm	33
118 91 0294	Roux hák sada fig.1-3; 16,5 cm	Roux retractor set fig.1-3; 16,5 cm	34
118 91 0295	Roux hák fig.1	Roux retractor fig.1	34
118 91 0296	Roux hák fig.2	Roux retractor fig.2	34
118 91 0297	Roux hák fig.3	Roux retractor fig.3	34
118 99 0086	Hák intraorální malý; 22,9 cm	Intraolar hook; small; 22,9 cm	35
119	Rozvěrače	Retractors	
119 07 0010	Roser-König rozvěrač úst; 19,5 cm	Roser-König mouth retractor; 19,5 cm	36
119 07 0020	Heister rozvěrač úst; 13,0 cm	Heister mouth retractor; 13,0 cm	36
119 91 0185	Jennings rozvěrač úst; 9,0 cm	Jennings mouth retractor; 9,0 cm	36
119 91 0186	Jennings rozvěrač úst; 11,0 cm	Jennings mouth retractor; 11,0 cm	36
119 91 0187	Jennings rozvěrač úst; 13,0 cm	Jennings mouth retractor; 13,0 cm	36
119 91 0188	Jennings rozvěrač úst; 15,0 cm	Jennings mouth retractor; 15,0 cm	36
119 91 0190	Whitehead rozvěrač úst; 11,0 cm	Whitehead mouth retractor; 11,0 cm	36
119 91 0191	Whitehead rozvěrač úst; 13,0 cm	Whitehead mouth retractor; 13,0 cm	36
119 91 0192	Whitehead rozvěrač úst; 15,0 cm	Whitehead mouth retractor; 15,0 cm	36
119 91 0194	Whitehead rozvěrač úst; 11,0 cm	Whitehead mouth retractor; 11,0 cm	36
119 91 0195	Whitehead rozvěrač úst; 13,0 cm	Whitehead mouth retractor; 13,0 cm	36
119 91 0196	Whitehead rozvěrač úst; 15,0 cm	Whitehead mouth retractor; 15,0 cm	36
121	Lopatky	Spatulas	
121 31 0010	Buchwald lopatka na jazyk; 16×23 mm; 17,3 cm	Buchwald tongue spatula; 16×23 mm; 17,3 cm	72
121 31 0020	Brünnings lopatka na jazyk; 14×18 mm; 19,5 cm	Brünnings tongue spatula; 14×18 mm; 19,5 cm	72
121 52 0010	Lopatka na cement oboustranná; 5 mm; 18,0 cm	Cement spatula; 5 mm; 18,0 cm	93, 114
121 52 0020	Lopatka na cement oboustranná; 7,5 mm; 18,0 cm	Cement spatula; 7,5 mm; 18,0 cm	93, 114
121 52 0050	Nůž na sádku s otvíračem kyvet; 18,0 cm	Plaster knife; 18,0 cm	114
121 52 0060	Lopatka na sádku; 16,8 cm	Plaster spatula; 16,8 cm	114
121 52 0080	Lopatka na míchání otiskov.hmot; 21,0 cm	Mixing spatula; 21,0 cm	93, 114
122	Zrcátka	Mirrors	
122 51 0010	Zrcátko zubní ploché; 24 mm	Mouth mirror flat; 24 mm	73
122 51 0020	Zrcátko zubní zvětšovací; 24 mm	Mouth mirror magnifying; 24 mm	73
122 51 0100	Držátko zubního zrcátka; 12,0 cm	Mirror handle; 12,0 cm	73
122 51 0106	Držátko zubního zrcátka; 12,0 cm	Mirror handle; 12,0 cm	73
122 56 0106	Držátko zubního zrcátka; 13,0 cm	Dental mirror hollow handle; 13,0 cm	73

číslo – number	název	item	strana – page
122 91 0333	Zrcátko zubní ploché HR Front; vel. 5; 24 mm	Mouth mirror flat HR Front; size 5; 24 mm	73
122 91 0407	Zrcátko zubní ploché HR Front; vel. 4; 22 mm	Mouth mirror flat HR Front; size 4; 22 mm	73
122 91 0408	Zrcátko zubní ploché HR Front; vel. 0; 14 mm	Mouth mirror flat HR Front; size 0; 14 mm	73
122 91 0411	Zrcátko zubní ploché HR Front; vel. 8; 30 mm	Mouth mirror flat HR Front; size 8; 30 mm	73
122 91 0420	Zrcátko intraorální bukální HR Front jednostranné; 16,0 cm	Intraoral mirror buccal HR Front one-side coated; 16,0 cm	72
122 91 0421	Zrcátko intraorální okluzní HR Front jednostranné; 15,0 cm	Intraoral mirror occlusal HR Front one-side coated; 15,0 cm	72
123	Páčidla, páky	Elevators	
123 08 0010	Langenbeck páčidlo fig. 1; 19,5 cm	Langenbeck elevator; fig. 1; 19,5 cm	20
123 08 0020	Langenbeck páčidlo fig. 2; 19,5 cm	Langenbeck elevator; fig. 2; 19,5 cm	20
123 08 0030	Williger páčidlo fig. 1; 16,0 cm	Williger elevator; fig. 1; 16,0 cm	20
123 30 0030	Freer páčidlo na nosní přepážku dvojité; 17,9 cm	Freer septum elevator; 17,9 cm	20
123 50 0010	Bein páka extrakční rovná; 3 mm; 14,5 cm	Bein root elevator straight; 3 mm; 14,5 cm	21
123 50 0011	Bein páka extrakční rovná; 3 mm; 16,5 cm	Bein root elevator straight; 3 mm; 16,5 cm	21
123 50 0020	Bein páka extrakční rovná; 4 mm; 14,5 cm	Bein root elevator straight; 4 mm; 14,5 cm	21
123 50 0021	Bein páka extrakční rovná; 4 mm; 16,5 cm	Bein root elevator straight; 4 mm; 16,5 cm	21
123 50 0050	Bein páka extrakční oblouk.; 3 mm; 14,5 cm	Bein root elevator embowed; 3 mm; 14,5 cm	21
123 50 0051	Bein páka extrakční oblouk.; 3 mm; 16,5 cm	Bein root elevator embowed; 3 mm; 16,5 cm	21
123 50 0060	Bein páka extrakční oblouk.; 4 mm; 14,5 cm	Bein root elevator embowed; 4 mm; 14,5 cm	21
123 50 0061	Bein páka extrakční oblouk.; 4 mm; 16,5 cm	Bein root elevator embowed; 4 mm; 16,5 cm	21
123 50 0080	Bein páka extrakční rovná jemná; 3 mm; 14,5 cm	Bein root elevator straight fine; 3 mm; 14,5 cm	22
123 50 0081	Bein páka extrakční rovná jemná; 3 mm; 16,5 cm	Bein root elevator straight fine; 3 mm; 16,5 cm	22
123 50 0090	Bein páka extrakční rovná jemná; 4 mm; 14,5 cm	Bein root elevator straight fine; 4 mm; 14,5 cm	22
123 50 0091	Bein páka extrakční rovná jemná; 4 mm; 16,5 cm	Bein root elevator straight fine; 4 mm; 16,5 cm	22
123 50 0100	Flohr páka extrakční hrotnatá pravá; 3 mm; 13,0 cm	Flohr root elevator pointed right fine; 3 mm; 13,0 cm	22
123 50 0101	Flohr páka extrakční hrotnatá pravá; 3 mm; 15,0 cm	Flohr root elevator pointed right fine; 3 mm; 15,0 cm	22
123 50 0110	Flohr páka extrakční hrotnatá levá; 3 mm; 13,0 cm	Flohr root elevator pointed left fine; 3 mm; 13,0 cm	22
123 50 0111	Flohr páka extrakční hrotnatá levá; 3 mm; 15,0 cm	Flohr root elevator pointed left fine; 3 mm; 15,0 cm	22
123 50 0130	Schlemmer páka extrakční pravá; 15,1 cm	Schlemmer root elevator right; 15,1 cm	23
123 50 0131	Schlemmer páka extrakční pravá; 17,1 cm	Schlemmer root elevator right; 17,1 cm	23
123 50 0140	Schlemmer páka extrakční levá; 15,1 cm	Schlemmer root elevator left; 15,1 cm	23
123 50 0141	Schlemmer páka extrakční levá; 17,1 cm	Schlemmer root elevator left; 17,1 cm	23
123 50 0160	Páka extrakční rovná pravá; 4 mm; 14,5 cm	Root elevator straight right; 4 mm; 14,5 cm	23
123 50 0170	Páka extrakční rovná levá; 4 mm; 14,5 cm	Root elevator straight left; 4 mm; 14,5 cm	23
123 50 0210	Špinar páka extrakční přední; 4 mm; 14,8 cm	Špinar root elevator frontal; 4 mm; 14,8 cm	24
123 50 0220	Špinar páka extrakční zadní; 4 mm; 14,8 cm	Špinar root elevator retral; 4 mm; 14,8 cm	24
123 50 0301	Barry páka extrakční pravá; 9,5 mm; 12,4 cm	Barry root elevator right; 9,5 mm; 12,4 cm	25
123 50 0311	Barry páka extrakční levá; 9,5 mm; 12,4 cm	Barry root elevator left; 9,5 mm; 12,4 cm	25
123 50 0361	Lecluse páka extrakční; 6,5 mm; 10,8 cm	Lecluse root elevator; 6,5 mm; 10,8 cm	25
123 50 0610	Nástroj na snímání korunek; 23,3 cm	Crown remover; 23,3 cm	96
123 50 0630	Páka extrakční se zuby rovná; 4 mm; 14,5 cm	Root elevator with saw edge; 4 mm; 14,5 cm	25
123 91 0006	Freer páčidlo nosní ostré; 19,0 cm	Freer nasal elevator; 19,0 cm	20
123 91 0007	Freer páčidlo nosní tupé; 19,0 cm	Freer nasal elevator; 19,0 cm	20
123 91 0008	Freer páčidlo nosní ostro-tupé; 18,0 cm	Freer nasal elevator; 18,0 cm	20
123 99 0084	Páčidlo na nosní přepážku; 3,8/4,2 mm; 17,0 cm	Septum nasal elevator; 3,8/4,2 mm; 17,0 cm	20
124	Škrabky	Raspatories	
124 08 0111	Williger škrabka fig. 2; 16,0 cm	Williger raspatory; fig. 2; 16,0 cm	26
124 08 0120	Langenbeck škrabka; 20,5 cm	Langenbeck raspatory; 20,5 cm	26
124 08 0130	Langenbeck škrabka; 20,4 cm	Langenbeck raspatory; 20,4 cm	26
124 08 0250	Williger škrabka 5 mm; 18,0 cm	Williger raspatory; 18,0 cm	26
124 08 0280	Williger škrabka rovná 3,5 mm; 16,0 cm	Williger raspatory; 16,0 cm	26
124 08 0290	Williger škrabka zahnutá 3,5 mm; 16,0 cm	Williger raspatory; 16,0 cm	26
124 30 0020	Přecechtěl škrabka nosní; 19,0 cm	Přecechtěl nasal raspatory; 19,0 cm	26
124 38 0160	Škrabka na operaci slzného vaku; 17,2 cm	Lachrymal sac raspatory; 17,2 cm	26
125	Lžičky	Bone Curettes, Spoons	
125 08 0110	Lžička ostrá fig. 000; 17,0 cm	Sharp spoon; fig. 000; 17,0 cm	38
125 08 0120	Lžička ostrá fig. 0; 17,2 cm	Sharp spoon; fig. 0; 17,2 cm	38
125 08 0130	Lžička ostrá fig. 1; 17,5 cm	Sharp spoon; fig. 1; 17,5 cm	38
125 08 0140	Lžička ostrá fig. 3; 17,7 cm	Sharp spoon; fig. 3; 17,7 cm	38
125 08 0150	Lžička ostrá fig. 5; 18,4 cm	Sharp spoon; fig. 5; 18,4 cm	38
125 08 0160	Lžička ostrá fig. 1; 16,5 cm	Sharp spoon; fig. 1; 16,5 cm	38
125 08 0170	Lžička ostrá fig. 2; 16,5 cm	Sharp spoon; fig. 2; 16,5 cm	38
125 08 0180	Lžička ostrá fig. 3; 17,5 cm	Sharp spoon; fig. 3; 17,5 cm	38
125 08 0190	Lžička ostrá fig. 4; 17,5 cm	Sharp spoon; fig. 4; 17,5 cm	38
125 08 0200	Lžička ostrá fig. 5; 19,5 cm	Sharp spoon; fig. 5; 19,5 cm	38
125 08 0210	Lžička ostrá fig. 6; 19,5 cm	Sharp spoon; fig. 6; 19,5 cm	38
125 50 0010	Lžička oboustranná; 17,0 cm	Bone curette double-faced; 17,0 cm	37
125 50 0050	Lžička oboustranná lomená ostrá; 2 mm; 17,0 cm	Bone curette double-faced; 2 mm; 17,0 cm	37
125 50 0060	Lžička oboustranná lomená ostrá; 3 mm; 17,0 cm	Bone curette double-faced; 3 mm; 17,0 cm	37
125 50 0070	Lžička oboustranná lomená ostrá; 4 mm; 17,0 cm	Bone curette double-faced; 4 mm; 17,0 cm	37

číslo – number	název	item	strana – page
125 50 0090	Lžička oboustranná lomená ostrá; 6 mm; 17,0 cm	Bone curette double-faced; 6 mm; 17,0 cm	37
125 51 0156	Lžička oboustranná ostrá; 1,5 mm; 16,6 cm	Bone curette double-faced; 1,5 mm; 16,6 cm	37
125 51 0166	Lžička oboustranná ostrá; 2,0 mm; 17,4 cm	Bone curette double-faced; 2,0 mm; 17,4 cm	37
125 51 0176	Lžička oboustranná ostrá; 2,5 mm; 16,6 cm	Bone curette double-faced; 2,5 mm; 16,6 cm	37
125 53 0010	Lžička laboratorní; 15,0 cm	Laboratory spoon; 15,0 cm	114
125 53 0020	Lžička laboratorní; 20,0 cm	Laboratory spoon; 20,0 cm	114
125 56 0066	Lžička ostrá oboustranná; 3,0 mm; 16,7 cm	Bone curette double-faced hollow handle; 3,0 mm; 16,7 cm	37
125 56 0156	Lžička ostrá oboustranná; 1,5 mm; 16,6 cm	Bone curette double-faced hollow handle; 1,5 mm; 16,6 cm	37
125 56 0166	Lžička ostrá oboustranná; 2,0 mm; 16,6 cm	Bone curette double-faced hollow handle; 2,0 mm; 16,6 cm	37
125 56 0176	Lžička ostrá oboustranná; 2,5 mm; 16,6 cm	Bone curette double-faced hollow handle; 2,5 mm; 16,6 cm	37
126	Kyrety	Curettes	
126 53 0010	Testovací tyčinka PMMA	Plastic test stick	103
126 58 0056	Gracey kyreta 1/2; 17,4 cm	Gracey curette 1/2; 17,4 cm	100, 102
126 58 0066	Gracey kyreta 3/4; 17,4 cm	Gracey curette 3/4; 17,4 cm	100, 102
126 58 0076	Gracey kyreta 5/6; 17,3 cm	Gracey curette 5/6; 17,3 cm	100, 102
126 58 0086	Gracey kyreta 7/8; 17,0 cm	Gracey curette 7/8; 17,0 cm	100, 102
126 58 0096	Scaler oboustranný; 16,7 cm	Scaler double-faced; 16,7 cm	102, 103
126 58 0106	Gracey kyreta 11/12; 17,2 cm	Gracey curette 11/12; 17,2 cm	100, 102
126 58 0116	Gracey kyreta 13/14; 17,0 cm	Gracey curette 13/14; 17,0 cm	100, 102
126 58 0126	Gracey kyreta 15/16; 17,1 cm	Gracey curette 15/16; 17,1 cm	100, 102
126 58 0136	Gracey kyreta 17/18; 15,6 cm	Gracey curette 17/18; 15,6 cm	100, 102
126 58 0146	Gracey kyreta 9/10; 16,5 cm	Gracey curette 9/10; 16,5 cm	100, 102
126 58 1056	Mini Gracey kyreta 1/2; 17,6 cm	Mini Gracey curette 1/2; 17,6 cm	101, 102
126 58 1066	Mini Gracey kyreta 3/4; 17,4 cm	Mini Gracey curette 3/4; 17,4 cm	101, 102
126 58 1076	Mini Gracey kyreta 5/6; 17,5 cm	Mini Gracey curette 5/6; 17,5 cm	101, 102
126 58 1086	Mini Gracey kyreta 7/8; 17,1 cm	Mini Gracey curette 7/8; 17,1 cm	101, 102
126 58 1106	Mini Gracey kyreta 11/12; 17,4 cm	Mini Gracey curette 11/12; 17,4 cm	101, 102
126 58 1116	Mini Gracey kyreta 13/14; 17,4 cm	Mini Gracey curette 13/14; 17,4 cm	101, 102
126 58 1126	Mini Gracey kyreta 15/16; 17,2 cm	Mini Gracey curette 15/16; 17,2 cm	101, 102
126 58 1136	Mini Gracey kyreta 17/18; 15,8 cm	Mini Gracey curette 17/18; 15,8 cm	101, 102
126 58 1146	Mini Gracey kyreta 9/10; 16,7 cm	Mini Gracey curette 9/10; 16,7 cm	101, 102
126 91 0162	Obtahovací kamínek na ostření kyret	Sharpening stone for currettes	103
127	Pilky, Pilníky	Saws, Files	
127 08 0270	Pilník; 15,9 cm	Rasp; 15,9 cm	27
127 30 0100	Joseph pilník, fig. 1; 16,5 cm	Joseph rasp; fig. 1; 16,5 cm	27
127 30 0110	Joseph pilník, fig. 2; 16,5 cm	Joseph rasp; fig. 2; 16,5 cm	27
127 30 0120	Joseph pilník, fig. 3; 16,5 cm	Joseph rasp; fig. 3; 16,5 cm	27
127 50 0001	List k pilce upínací stomatologické; 7,3 cm	Blade of stomatological saw; 7,3 cm	112
127 50 0150	Rám upínací pilky stomatologické; 19,0 cm	Frame of stomatological saw; 19,0 cm	112
128	Dláta, Kladiva	Chisels, Mallets	
128 08 0901	Kladívko chirurgické kovové; 250 g	Surgical mallet; 250 g	29
128 08 0911	Kladívko chirurgické kovové; 500 g	Surgical mallet; 500 g	29
128 30 0010	Dláto žlábkové; 180x2 mm	Gouge grooved; 180x2 mm	28
128 30 0030	Dláto žlábkové; 180x4 mm	Gouge grooved; 180x4 mm	28
128 30 0040	Dláto žlábkové; 180x5 mm	Gouge grooved; 180x5 mm	28
128 30 0200	West dláto žlábkové; 180x2 mm	West gouge grooved; 180x2 mm	28
128 30 0230	West dláto žlábkové; 180x5 mm	West gouge grooved; 180x5 mm	28
128 52 0110	Kladívko laboratorní ocelové; 26,0 cm	Laboratory mallet; 26,0 cm	116
128 52 0111	Kladívko laboratorní ocelové; 26,0 cm	Laboratory mallet; 26,0 cm	116
132	Jehelce, Zavaděče	Needle Holders, Introducers	
132 06 0200	Mathieu jehelec bez drážky; 14,0 cm	Mathieu needle holder; 14,0 cm	48
132 06 0220	Mathieu jehelec bez drážky; 17,2 cm	Mathieu needle holder; 17,2 cm	48
132 06 0300	Crile jehelec jemný; 15,0 cm	Crile needle holder fine; 15,0 cm	48
132 06 0341	Jehelec hloubk. rovný provlékací zámek; 16,5 cm	Needle holder; 16,5 cm	48
132 06 0370	Crile jehelec jemný diamantovaný; 1,6 mm; 15,7 cm	Crile needle holder dia; 1,6 mm; 15,7 cm	50
132 06 0450	Crile jehelec jemný provlékací zámek (vločka sk); 16,2 cm	Crile needle holder TUC; 16,2 cm	50
132 06 0500	Mathieu jehelec provl. zámek (vločka SK); 17,2 cm	Mathieu needle holder TUC; 17,2 cm	50
132 06 0510	Mathieu jehelec provl. zámek (vločka SK); 21,5 cm	Mathieu needle holder TUC; 21,5 cm	50
132 06 0520	Mathieu jehelec provl. zámek (vločka SK); 14,0 cm	Mathieu needle holder TUC; 14,0 cm	50
132 06 0600	Ryder jehelec tvrdokov; 16,5 cm	Ryder needle holder TUC; 16,5 cm	49
132 06 0610	Jehelec hloubk. rovný (vločka SK) tvrdokov; 16,5 cm	Needle holder TUC; 16,5 cm	49
132 06 0640	Ryder jehelec tvrdokov; 20,5 cm	Ryder needle holder TUC; 20,5 cm	49
132 06 0650	Ryder jehelec tvrdokov; 25,5 cm	Ryder needle holder TUC; 25,5 cm	49
132 06 0810	Jehelec s vnitřním uzávěrem vroubk.; 20,5 cm	Needle holder; 20,5 cm	48
132 38 0120	Boynton jehelec oční; 12,5 cm	Boynton eye needle holder; 12,5 cm	48
132 50 0180	Luniatschek zavaděč drenů; 17,0 cm	Luniatschek drain introducer; 17,0 cm	52
132 50 0186	Luniatschek zavaděč drenů; 16,7 cm	Luniatschek drain introducer; 16,7 cm	52
132 50 0196	Luniatschek zavaděč drenů se žlábkem; 16,7 cm	Luniatschek drain introducer with groove; 16,7 cm	52
132 56 0186	Luniatschek zavaděč drenů; 16,8 cm	Luniatschek drain introducer hollow handle; 16,8 cm	52

číslo – number	název	item	strana – page
132 91 0056	Mathieu jehelec bez drážky; 20,0 cm	Mathieu needle holder; 20,0 cm	48
132 91 0057	Mathieu jehelec bez drážky; 24,0 cm	Mathieu needle holder; 24,0 cm	48
132 91 0160	Olsen-Hegar jehelec/nůžky tvrdokov; 14,0 cm	Olsen-Hegar needle holder/scs. TUC; 14,0 cm	49
132 91 0161	Olsen-Hegar jehelec/nůžky tvrdokov; 17,0 cm	Olsen-Hegar needle holder/scs. TUC; 17,0 cm	49
132 91 0162	Olsen-Hegar jehelec/nůžky tvrdokov; 19,0 cm	Olsen-Hegar needle holder/scs. TUC; 19,0 cm	49
132 91 0168	Mathieu jehelec jemný tvrdokov; 17,0 cm	Mathieu needle holder TUC; 17,0 cm	50
132 91 0169	Mathieu jehelec jemný tvrdokov; 20,0 cm	Mathieu needle holder TUC; 20,0 cm	50
132 91 0170	Mathieu jehelec jemný tvrdokov; 23,0 cm	Mathieu needle holder TUC; 23,0 cm	50
132 91 0182	Boynton jehelec oční tvrdokov; 12,5 cm	Boynton eye needle holder; 12,5 cm	50
132 91 0215	Castroviejo jehelec rovný vroubkovaný tvrdokov; 14,0 cm	Castroviejo needle holder TUC; 14,0 cm	51
132 91 0216	Castroviejo jehelec zahnutý vroubkovaný tvrdokov; 14,0 cm	Castroviejo needle holder TUC; 14,0 cm	51
132 91 0219	Castroviejo jehelec rovný vroubkovaný tvrdokov; 18,0 cm	Castroviejo micro-needle holder TUC; 18,0 cm	51
132 91 0220	Castroviejo jehelec zahnutý vroubkovaný tvrdokov; 18,0 cm	Castroviejo micro-needle holder TUC; 18,0 cm	51
132 91 0221	Jacobson jehelec mikro hladký tvrdokov; 21,0 cm	Jacobson micro-needle holder TUC; 21,0 cm	51
132 91 0222	Jacobson jehelec mikro vroubkovaný tvrdokov; 21,0 cm	Jacobson micro-needle holder TUC; 21,0 cm	51
132 91 0257	Castroviejo jehelec mikro rovný hladký; 14,0 cm	Castroviejo micro-needle holder; 14,0 cm	51
132 91 0258	Castroviejo jehelec mikro zahnutý hladký; 14,0 cm	Castroviejo micro-needle holder; 14,0 cm	51
132 91 0259	Castroviejo jehelec mikro rovný vroubkovaný; 14,0 cm	Castroviejo micro-needle holder; 14,0 cm	51
132 91 0260	Castroviejo jehelec mikro zahnutý vroubkovaný; 14,0 cm	Castroviejo micro-needle holder; 14,0 cm	51
132 91 0261	Castroviejo jehelec rovný hladký s uzávěrem; 14,0 cm	Castroviejo micro-needle holder; 14,0 cm	51
132 91 0262	Castroviejo jehelec zahnutý hladký s uzávěrem; 14,0 cm	Castroviejo micro-needle holder; 14,0 cm	51
132 91 0263	Castroviejo jehelec rovný vroubk. s uzávěrem; 14,0 cm	Castroviejo micro-needle holder; 14,0 cm	51
132 91 0264	Castroviejo jehelec zahnutý vroubk. s uzávěrem; 14,0 cm	Castroviejo micro-needle holder; 14,0 cm	51
133	Sondy, pátradla	Probes	
133 38 0060	Bowmann pátradlo oční nerez; 0,5 mm; 13,0 cm	Bowmann eye probe; 0,5 mm; 13,0 cm	71
133 38 0070	Bowmann pátradlo oční nerez; 0,7 mm; 13,0 cm	Bowmann eye probe; 0,7 mm; 13,0 cm	71
133 38 0080	Bowmann pátradlo oční nerez; 0,9 mm; 13,0 cm	Bowmann eye probe; 0,9 mm; 13,0 cm	71
133 50 0106	Sonda parodontolog. 3,5; 5,5; 8,5; 11,5 mm; 15,2 cm	Periodontal probe; 3,5; 5,5; 8,5; 11,5 mm; 15,2 cm	99
133 50 0116	Sonda parodontolog. 1; 2; 3; 5; 7; 9; 11; 13 mm; 15,2 cm	Periodontal probe; 2; 3; 5; 7; 9; 11; 13 mm; 15,2 cm	99
133 51 0010	Pátradlo zubní háčkové krátké; 15,2 cm	Dental probe short hooked; 15,2 cm	71
133 51 0016	Pátradlo zubní háčkové krátké; 15,2 cm	Dental probe short hooked; 15,2 cm	71
133 51 0020	Pátradlo zubní háčkové dlouhé; 15,1 cm	Dental probe long hooked; 15,1 cm	71
133 51 0026	Pátradlo zubní háčkové dlouhé; 15,1 cm	Dental probe long hooked; 15,1 cm	71
133 51 0030	Pátradlo zubní obloukové; 14,5 cm	Dental probe embowed; 14,5 cm	71
133 51 0036	Pátradlo zubní obloukové; 14,5 cm	Dental probe embowed; 14,5 cm	71
133 51 0040	Pátradlo zubní vyhnuté krátké; 15,0 cm	Dental probe short angled; 15,0 cm	71
133 51 0046	Pátradlo zubní vyhnuté krátké; 15,0 cm	Dental probe short angled; 15,0 cm	71
133 51 0050	Pátradlo zubní vyhnuté dlouhé; 14,0 cm	Dental probe long angled; 14,0 cm	71
133 51 0056	Pátradlo zubní vyhnuté dlouhé; 14,0 cm	Dental probe long angled; 14,0 cm	71
133 56 0016	Pátradlo zubní háčkové krátké; 16,3 cm	Dental probe short hooked hollow handle; 16,3 cm	71
133 56 0026	Pátradlo zubní háčkové dlouhé; 16,2 cm	Dental probe long hooked hollow handle; 16,2 cm	71
133 56 0036	Pátradlo zubní obloukové; 15,6 cm	Dental probe embowed hollow handle; 15,6 cm	71
133 56 0046	Pátradlo zubní vyhnuté krátké; 16,1 cm	Dental probe short angled hollow handle; 16,1 cm	71
133 56 0056	Pátradlo zubní vyhnuté dlouhé; 15,1 cm	Dental probe long angled hollow handle; 15,1 cm	71
133 58 0230	Nabers furkační sonda 3-6-9-12; 17,2 cm	Nabers furcation probe 3-6-9-12; 17,2 cm	99
133 99 0177	Sonda parodontologická s pátradlem; 15,7 cm	Periodontal and dental probe; 15,7 cm	99
133 99 0186	Pátradlo zubní obloukové, háčkové krátké; 15,7 cm	Dental probe embowed, short hooked; 15,7 cm	71
136	Nástroje speciální	Special Instruments	
136 39 0010	Toulec na pinzety; 9,0 cm	Quiver for tweezers; 9,0 cm	124
136 39 0020	Toulec na podávkové kleště; 20,0 cm	Quiver for forceps; 20,0 cm	124
136 39 0050	Toulec na pinzety s podstavcem; 11,0 cm	Tweezer quiver with stand; 11,0 cm	124
136 39 0060	Toulec na kleště s podstavcem; 20,0 cm	Forceps quiver with stand; 20,0 cm	124
136 39 0070	Toulec na pinzety s podstavcem; 9,0 cm	Tweezer quiver with stand; 9,0 cm	124
136 39 0110	Tácek dentální; 180×120×15 mm	Dental tray; 180×120×15 mm	127
136 39 0140	Krabička sterilizační; nerez; 200×100×30 mm	Sterilization box; 200×100×30 mm	126
136 39 0150	Krabička sterilizační; nerez; 170×70×30 mm	Sterilization box; 170×70×30 mm	126
136 39 0160	Krabička sterilizační; nerez; 200×100×40 mm	Sterilization box; 200×100×40 mm	126
136 39 0170	Krabička s rovným víkem/úch.; nerez; 210×115×45 mm	Box; 210×115×45 mm	126
136 39 0180	Krabička s příhrádkami dvojí víčko; 210×110×25 mm	Box; 210×110×25 mm	126
136 39 0190	Krabička s vypouklým víčkem; 210×115×45 mm	Box; 210×115×45 mm	126
136 39 0200	Krabička na katetry, víčko s úch.; nerez; 300×80×40 mm	Box; 300×80×40 mm	126
136 39 0210	Krabička s bočními prohlubněmi; nerez; 92×40×17 mm	Box; 92×40×17 mm	127
136 39 0211	Krabička kulatá; nerez; 65×15 mm	Box round; 65×15 mm	125
136 39 0212	Krabička kulatá perforovaná; nerez; 62×13 mm	Box round perforated; 62×13 mm	125
136 39 0213	Krabička kulatá; nerez; 40×13 mm	Box round; 40×13 mm	125
136 39 0214	Krabička kulatá; nerez; 80×18 mm	Box round; 80×18 mm	125
136 39 0215	Krabička kulatá; nerez; 90×20 mm	Box round; 90×20 mm	125
136 39 0216	Krabička kulatá; nerez; 100×20 mm	Box round; 100×20 mm	125
136 39 0220	Krabička s poklopem a úchytem; nerez; 350×90×50 mm	Box; 350×90×50 mm	126

číslo – number	název	item	strana – page
136 39 0230	Krabička s poklopem a úchytem; nerez; 230×150×60 mm	Box; 230×150×60 mm	126
136 39 0240	Krabička s poklopem a rov.úch.; nerez; 300×200×50 mm	Box; 300×200×50 mm	126
136 39 0250	Krabička s poklopem a rov. úch.; nerez; 200×150×45 mm	Box; 200×150×45 mm	126
136 39 0260	Nádobka oválná – emitní miska; nerez; 175×100×25 mm	Bowl; 175×100×25 mm	125
136 39 0270	Nádobka kovová; nerez; 90×40 mm	Bowl; 90×40 mm	125
136 39 0320	Nádobka medicínská kovová; 82×30 mm	Bowl; 82×30 mm	125
136 39 0330	Tácek; nerez; 200×100×10 mm	Tray; 200×100×10 mm	127
136 39 0340	Tácek s drážkami; nerez; 180×90×15 mm	Tray; 180×90×15 mm	127
136 39 0350	Tácek hluboký; nerez; 200×100×30 mm	Tray; 200×100×30 mm	127
136 39 0360	Tácek; nerez; 190×100×10 mm	Tray; 190×100×10 mm	127
136 39 0370	Tácek; nerez; 280×180×25 mm	Tray; 280×180×25 mm	127
136 39 0380	Tácek; nerez; 350×250×25 mm	Tray; 350×250×25 mm	127
136 91 0001	Langenbeck chránič prstu	Langenbeck finger protector	35
136 91 0002	Langenbeck chránič prstu	Langenbeck finger protector	35
136 91 0003	Langenbeck chránič prstu	Langenbeck finger protector	35
139	Stomatologické soubory	Stomatological Sets	
139 50 0150	Držák	Holder	125
139 50 0160	Kazeta s držákem	Cassette with holder	125
139 50 0170	Kazeta pro stomatologické nástroje	Cassette	125
139 50 0770	Soubor parodontologických nástrojů, set 1	Set of periodontal instruments, set 1	102
139 50 0780	Soubor parodontologických nástrojů, set 2	Set of periodontal instruments, set 2	102
139 50 0810	Soubor parodontologických nástrojů Mini, set 1	Set of mini periodontal instruments, set 1	102
147	Nástroje na zubní kámen	Scalers	
147 51 0010	Nástroj na zubní kámen; 15,5 cm	Scaler; 15,5 cm	104
147 51 0016	Nástroj na zubní kámen; 15,5 cm	Scaler; 15,5 cm	104
147 51 0018	Nástroj na zubní kámen; 15,5 cm TiN	Scaler TiN; 15,5 cm	104
147 51 0020	Drápek na zubní kámen; 15,5 cm	Scaler; 15,5 cm	104
147 51 0026	Drápek na zubní kámen; 15,5 cm	Scaler; 15,5 cm	104
147 51 0028	Drápek na zubní kámen; 15,5 cm TiN	Scaler TiN; 15,5 cm	104
147 51 0030	Srpek na zubní kámen; 0,6 mm; 15,5 cm	Scaler; 0,6 mm; 15,5 cm	104
147 51 0036	Srpek na zubní kámen; 0,6 mm; 15,5 cm	Scaler; 0,6 mm; 15,5 cm	104
147 51 0038	Srpek na zubní kámen; 0,6 mm; 15,5 cm TiN	Scaler TiN; 0,6 mm; 15,5 cm	104
147 51 0040	Srpek na zubní kámen; 0,9 mm; 15,5 cm	Scaler; 0,9 mm; 15,5 cm	104
147 51 0046	Srpek na zubní kámen; 0,9 mm; 15,5 cm	Scaler; 0,9 mm; 15,5 cm	104
147 51 0048	Srpek na zubní kámen; 0,9 mm; 15,5 cm TiN	Scaler TiN; 0,9 mm; 15,5 cm	104
147 51 0060	Srpek na zubní kámen 2xlomený; 15,5, cm	Scaler double angled; 15,5, cm	105
147 51 0066	Srpek na zubní kámen 2xlomený; 15,5, cm	Scaler double angled; 15,5, cm	105
147 51 0068	Srpek na zubní kámen 2xlomený; 15,5, cm TiN	Scaler double angled TiN; 15,5, cm	105
147 51 0070	Škrabka na zubní kámen pravá; 2 mm; 15,5 cm	Scaler right; 2 mm; 15,5 cm	105
147 51 0080	Škrabka na zubní kámen pravá; 3 mm; 15,5 cm	Scaler right; 3 mm; 15,5 cm	105
147 51 0100	Škrabka na zubní kámen levá; 2 mm; 15,5 cm	Scaler left; 2 mm; 15,5 cm	105
147 51 0110	Škrabka na zubní kámen levá; 3 mm; 15,5 cm	Scaler left; 3 mm; 15,5 cm	105
147 51 0270	Nástroj na zubní kámen levý; 2,5 mm; 15,5 cm	Cutting instrument left; 2,5 mm; 15,5 cm	107
147 51 0806	Zešikmovač gingiválních okrajů distální; 16,6 cm	Gingival margin trimmer distal; 16,6 cm	106
147 51 0816	Zešikmovač gingiválních okrajů meziální; 16,6 cm	Gingival margin trimmer mesial; 16,6 cm	106
148	Exkavátory	Excavators	
148 51 0010	Exkavátor jednostranný rovný; 2,0 mm; 15,5 cm	Excavator straight; 2,0 mm; 15,5 cm	77
148 51 0016	Exkavátor jednostranný rovný; 2,0 mm; 15,5 cm	Excavator straight; 2,0 mm; 15,5 cm	77
148 51 0056	Exkavátor jednostr.zahnutý pravý; 1,5 mm; 15,5 cm	Excavator curved right; 1,5 mm; 15,5 cm	77
148 51 0076	Exkavátor jednostr.zahnutý levý; 1,5 mm; 15,5 cm	Excavator curved left; 1,5 mm; 15,5 cm	77
148 51 0096	Exkavátor oboustranný; 0,8/1,0 mm; 16,8 cm	Excavator double-faced; 0,8/1,0 mm; 16,8 cm	78
148 51 0100	Exkavátor oboustranný; 1,5 mm; 17,0 cm	Excavator double-faced; 1,5 mm; 17,0 cm	78
148 51 0106	Exkavátor oboustranný; 1,5 mm; 16,8 cm	Excavator double-faced; 1,5 mm; 16,8 cm	78
148 51 0110	Exkavátor oboustranný; 2,0 mm; 17,0 cm	Excavator double-faced; 2,0 mm; 17,0 cm	78
148 51 0116	Exkavátor oboustranný; 2,0 mm; 16,8 cm	Excavator double-faced; 2,0 mm; 16,8 cm	78
148 51 0120	Exkavátor oboustranný; 2,5 mm; 17,0 cm	Excavator double-faced; 2,5 mm; 17,0 cm	78
148 51 0126	Exkavátor oboustranný; 2,5 mm; 16,8 cm	Excavator double-faced; 2,5 mm; 16,8 cm	78
148 51 0136	Exkavátor oboustranný; 1,0 mm; 16,8 cm	Excavator double-faced; 1,0 mm; 16,8 cm	78
151	Nástroje pro výplně	Filling Instruments	
151 51 0060	Nosič amalgamu s kříž. řezem; 1,2/3 mm; 17,0 cm	Plastic filling instrument – carrier; 1,2/3 mm; 17,0 cm	79
151 51 0066	Nosič amalgamu s kříž. řezem; 1,2/3 mm; 16,7 cm	Plastic filling instrument – carrier; 1,2/3 mm; 16,7 cm	79
151 51 0080	Cpátka amalgamu oboustranné; 2/3 mm; 17,0 cm	Plastic filling instrument – plugger; 2/3 mm; 17,0 cm	80
151 51 0086	Cpátka amalgamu oboustranné; 2/3 mm; 16,5 cm	Plastic filling instrument – plugger; 2/3 mm; 16,5 cm	80
151 51 0096	Cpátka amalgamu oboustranné; 2/3 mm; 16,5 cm	Plastic filling instrument – plugger; 2/3 mm; 16,5 cm	80
151 51 0097	Cpátka kompoz.mater.oboustr.; 2/3 mm; 17,0 cm TiN	Plastic filling instrument – plugger TiN; 2/3 mm; 17,0 cm	80
151 51 0160	Cpátka jednostr.kořenové lomené; 0,8 mm; 16,0 cm	Plastic filling instrument – plugger; 0,8 mm; 16,0 cm	82
151 51 0166	Cpátka jednostr.kořenové lomené; 0,8 mm; 15,8 cm	Plastic filling instrument – plugger; 0,8 mm; 15,8 cm	82
151 51 0170	Cpátka jednostr.kořenové lomené; 1,2 mm; 16,0 cm	Plastic filling instrument – plugger; 1,2 mm; 16,0 cm	82
151 51 0176	Cpátka jednostr.kořenové lomené; 1,2 mm; 15,8 cm	Plastic filling instrument – plugger; 1,2 mm; 15,8 cm	82

číslo – number	název	item	strana – page
151 51 0186	Cpátka oboustranné; 0,6/0,8 mm; 16,7 cm	Plastic filling instrument – plugger; 0,6/0,8 mm; 16,7 cm	84
151 51 0187	Cpátka oboustranné; 0,6/0,8 mm; 17,0 cm TiN	Plastic filling instrument – plugger TiN; 0,6/0,8 mm; 17,0 cm	82
151 51 0190	Cpátka oboustranné; 1,2/1,6 mm; 17,0 cm	Plastic filling instrument – plugger; 1,2/1,6 mm; 17,0 cm	82
151 51 0196	Cpátka oboustranné; 1,2/1,6 mm; 16,8 cm	Plastic filling instrument – plugger; 1,2/1,6 mm; 16,8 cm	82
151 51 0197	Cpátka oboustranné; 1,2/1,6 mm; 17,0 cm TiN	Plastic filling instrument – plugger TiN; 1,2/1,6 mm; 17,0 cm	82
151 51 0200	Cpátka oboustranné; 2,0/2,5 mm; 17,0 cm	Plastic filling instrument – plugger; 2,0/2,5 mm; 17,0 cm	82
151 51 0206	Cpátka oboustranné; 2,0/2,5 mm; 16,8 cm	Plastic filling instrument – plugger; 2,0/2,5 mm; 16,8 cm	82
151 51 0207	Cpátka oboustranné; 2,0/2,5 mm; 17,0 cm TiN	Plastic filling instrument – plugger TiN; 2,0/2,5 mm; 17,0 cm	82
151 51 0280	Cpátka oboustranné; 1,0/1,8 mm; 17,0 cm	Plastic filling instrument – plugger; 1,0/1,8 mm; 17,0 cm	81
151 51 0286	Cpátka oboustranné; 1,0/1,8 mm; 16,6 cm	Plastic filling instrument – plugger; 1,0/1,8 mm; 16,6 cm	81
151 51 0287	Cpátka oboustranné; 1,0/1,8 mm; 17,0 cm TiN	Plastic filling instrument – plugger TiN; 1,0/1,8 mm; 17,0 cm	81
151 51 0290	Cpátka oboustranné; 1,4/2,0 mm; 17,0 cm	Plastic filling instrument – plugger; 1,4/2,0 mm; 17,0 cm	81
151 51 0296	Cpátka oboustranné; 1,4/2,0 mm; 16,6 cm	Plastic filling instrument – plugger; 1,4/2,0 mm; 16,6 cm	81
151 51 0297	Cpátka oboustranné; 1,4/2,0 mm; 17,0 cm TiN	Plastic filling instrument – plugger TiN; 1,4/2,0 mm; 17,0 cm	81
151 51 0306	Cpátka oboustranné; 0,6/0,8 mm; 16,6 cm	Plastic filling instrument – plugger; 0,6/0,8 mm; 16,6 cm	81
151 51 0310	Cpátka kopýtkové oboustranné; 17,0 cm	Plastic filling instrument – plugger; 17,0 cm	81
151 51 0316	Cpátka kopýtkové oboustranné; 16,6 cm	Plastic filling instrument – plugger; 16,6 cm	81
151 51 0320	Cpátka oboustranné; 17,0 cm	Plastic filling instrument – plugger; 17,0 cm	80
151 51 0326	Cpátka oboustranné; 16,6 cm	Plastic filling instrument – plugger; 16,6 cm	80
151 51 0340	Hladítko se cpátkem fig. 3; 17,0 cm	Plastic filling instrument – spatula-plugger fig. 3; 17,0 cm	84
151 51 0346	Hladítko se cpátkem fig. 3; 16,6 cm	Plastic filling instrument – spatula-plugger fig. 3; 16,6 cm	84
151 51 0347	Hladítko se cpátkem fig. 3; 16,6 cm TiN	Plastic filling instrument – spatula-plugger fig. 3 TiN; 16,6 cm	84
151 51 0356	Hladítko se cpátkem; 1,0/1,5 mm; 16,4 cm	Plastic filling instrument – spatula-plugger; 1,0/1,5 mm; 16,4 cm	84
151 51 0416	Nosič amalgamu; 1,4/2,0 mm; 16,6 cm	Plastic filling instrument – carrier; 1,4/2,0 mm; 16,6 cm	79
151 51 0426	Nosič amalgamu; 2,5/3,0 mm; 17,0 cm	Plastic filling instrument – carrier; 2,5/3,0 mm; 17,0 cm	79
151 51 0466	Cpátka vlákna do sulku; 2 mm; 16,6 cm	Fibre filling instrument; 2 mm; 16,6 cm	83
151 51 0516	Zavaděč retrakčních vláken; 16,8 cm	Retentive fibre instrument; 16,8 cm	83
151 51 0526	Zavaděč retrakčních vláken; 16,8 cm	Retentive fibre instrument; 16,8 cm	83
151 51 0570	Hladítko pružné; 2,5 mm; 15,5 cm	Plastic filling instrument; 2,5 mm; 15,5 cm	86
151 51 0616	Nástroj na plast. výplně; 16,6 cm	Plastic filling instrument; 16,6 cm	90
151 51 0620	Hladítko oboustranné fig. 1; 17,0 cm	Plastic filling instrument – spatula fig. 1; 17,0 cm	87
151 51 0626	Hladítko oboustranné fig. 1; 16,6 cm	Plastic filling instrument – spatula fig. 1; 16,6 cm	87
151 51 0627	Hladítko oboustranné fig. 1; 16,6 cm TiN	Plastic filling instrument – spatula fig. 1 TiN; 16,6 cm	87
151 51 0630	Hladítko oboustranné fig. 2; 17,0 cm	Plastic filling instrument – spatula fig. 2; 17,0 cm	87
151 51 0636	Hladítko oboustranné fig. 2; 16,6 cm	Plastic filling instrument – spatula fig. 2; 16,6 cm	87
151 51 0637	Hladítko oboustranné fig. 2; 16,6 cm TiN	Plastic filling instrument – spatula fig. 2 TiN; 16,6 cm	87
151 51 0650	Hladítko oboustranné 3× lomené; 17,0 cm	Plastic filling instrument – spatula; 17,0 cm	86
151 51 0656	Hladítko oboustranné 3× lomené; 16,6 cm	Plastic filling instrument – spatula; 16,6 cm	86
151 51 0657	Hladítko oboustranné 3× lomené; 17,0 cm TiN	Plastic filling instrument – spatula TiN; 17,0 cm	86
151 51 0690	Hladítko oboustranné; 1,5 mm; 17,0 cm	Spatula – filling instrument; 1,5 mm; 17,0 cm	87
151 51 0696	Hladítko oboustranné; 1,5 mm; 16,6 cm	Spatula – filling instrument; 1,5 mm; 16,6 cm	87
151 51 0706	Heidemann hladítko oboustranné fig. 1; 16,6 cm	Heidemann spatula fig. 1; 16,6 cm	87
151 51 0716	Heidemann hladítko oboustranné fig. 2; 16,9 cm	Heidemann spatula fig. 2; 16,9 cm	87
151 51 0726	Heidemann hladítko oboustranné fig. 2; 17,3 cm	Heidemann spatula fig. 2; 17,3 cm	87
151 51 0760	Pistole na amalgam s kovovým pístem	Amalgam gun – metal piston	92
151 51 0770	Pistole na amalgam s kovovým pístem	Amalgam gun – metal piston	92
151 51 0806	Nástroj na modelování výplně; 1,6 mm; 16,4 cm	Modelling instrument; 1,6 mm; 16,4 cm	88
151 51 0836	Nástroj na modelování výplně; 2,5 mm; 16,4 cm	Modelling instrument; 2,5 mm; 16,4 cm	88
151 51 0846	Nástroj na modelování výplně; 2,5 mm; 16,4 cm	Modelling instrument; 2,5 mm; 16,4 cm	88
151 51 0856	Sapin nástroj na modelování výplně; 1,6 mm; 16,0 cm	Sapin modelling instrument; 1,6 mm; 16,0 cm	88
151 51 0866	Frahm nástroj na modelování výplně; 5,0 mm; 16,6 cm	Frahm modelling instrument; 5,0 mm; 16,6 cm	88
151 51 0876	Nástroj na modelování výplně; 1,4 mm; 16,6 cm	Modelling instrument; 1,4 mm; 16,6 cm	88
151 51 0886	Nástroj na modelování výplně; 1,6/2,5 mm; 16,4 cm	Modelling instrument; 1,6/2,5 mm; 16,4 cm	89
151 51 0896	Nástroj na modelování výplně; 2,2 mm; 16,8 cm	Modelling instrument; 2,2 mm; 16,8 cm	90
151 51 0936	Discoïd-Cleoid nástroj na výplně; 2,0/2,2 mm; 16,8 cm	Discoïd-Cleoid filling instrument; 2,0/2,2 mm; 16,8 cm	90
151 51 0970	Svorka na separační pásky 40° zahnutá; 3,3 cm	Strip clamp; 3,3 cm	91
151 51 0980	Svorka na separační pásky 90° zahnutá; 2,5 cm	Strip clamp; 2,5 cm	91
151 51 1010	Pásek separační hladký; 120×6 mm	Separative strip smooth; 120×6 mm	91
151 51 1020	Pásek separační hladký; 120×8 mm	Separative strip smooth; 120×8 mm	91
151 51 1496	Wiland nástroj na výplně oboustranný; 16,6 cm	Wiland amalgam carver double-faced; 16,6 cm	88
151 51 2020	Pásek separační diamant. 120×3 mm; D40	Separative strip diamond 120×3 mm; D40	91
151 51 2021	Pásek separační diamant. 120×3 mm; D64	Separative strip diamond 120×3 mm; D64	91
151 51 2022	Pásek separační diamant. 120×3 mm; D107	Separative strip diamond 120×3 mm; D107	91
151 51 2030	Pásek separační diamant. 120×4 mm; D40	Separative strip diamond 120×4 mm; D40	91
151 51 2031	Pásek separační diamant. 120×4 mm; D64	Separative strip diamond 120×4 mm; D64	91
151 51 2032	Pásek separační diamant. 120×4 mm; D107	Separative strip diamond 120×4 mm; D107	91
151 51 2040	Pásek separační diamant. 120×6 mm; D40	Separative strip diamond 120×6 mm; D40	91
151 51 2041	Pásek separační diamant. 120×6 mm; D64	Separative strip diamond 120×6 mm; D64	91
151 51 2042	Pásek separační diamant. 120×6 mm; D107	Separative strip diamond 120×6 mm; D107	91

číslo – number	název	item	strana – page
151 51 2051	Pásek separační diamant. 120×8 mm; D64	Separative strip diamond 120×8 mm; D64	91
151 51 2052	Pásek separační diamant. 120×8 mm; D107	Separative strip diamond 120×8 mm; D107	91
151 51 3006	Cpátko oboustran.kombinované; 0,8/1,0 mm; 16,6 cm	Plastic filling instrument – plugger; 0,8/1,0 mm; 16,6 cm	81
151 51 3016	Cpátko oboustran.kombinované; 1,2/1,4 mm; 16,6 cm	Plastic filling instrument – plugger; 1,2/1,4 mm; 16,6 cm	81
151 51 3026	Cpátko oboustran.kombinované; 1,6/2,0 mm; 16,6 cm	Plastic filling instrument – plugger; 1,6/2,0 mm; 16,6 cm	81
151 51 3076	Cpátko kulíčkové s hladítkem; 2,0/2,5 mm; 16,8 cm	Plastic filling instrument – spatula-plugger; 2,0/2,5 mm; 16,8 cm	85
151 51 3210	Nástroj pro výplně; 1,4 mm; 16,6 cm	Filling instrument; 1,4 mm; 16,6 cm	88
151 51 3220	Nástroj pro výplně; 2,0 mm; 16,6 cm	Filling instrument; 2,0 mm; 16,6 cm	88
151 51 3256	Cpátko kulíčkové s hladítkem; 1,2/1,5 mm; 16,4 cm	Plastic filling instrument – spatula-plugger; 1,2/1,5 mm; 16,4 cm	85
151 51 3620	Hladítko oboustranné jemné fig. 1; 17,0 cm	Plastic filling instrument – spatula fig. 1; 17,0 cm	87
151 51 3626	Hladítko oboustranné jemné fig. 1; 16,6 cm	Plastic filling instrument – spatula fig. 1; 16,6 cm	87
151 51 3627	Hladítko oboustranné jemné fig. 1; 16,6 cm TiN	Plastic filling instrument TiN – spatula fig. 1; 16,6 cm	87
151 51 3630	Hladítko oboustranné jemné fig. 2; 17,0 cm	Plastic filling instrument – spatula fig. 2; 17,0 cm	87
151 51 3636	Hladítko oboustranné jemné fig. 2; 16,6 cm	Plastic filling instrument – spatula fig. 2; 16,6 cm	87
151 51 3637	Hladítko oboustranné jemné fig. 2; 16,6 cm TiN	Plastic filling instrument TiN – spatula fig. 2; 16,6 cm	87
151 51 3650	Hladítko oboustranné jemné 3× lomené; 17,0 cm	Plastic filling instrument – spatula; 17,0 cm	86
151 51 3656	Hladítko oboustranné jemné 3× lomené; 16,6 cm	Plastic filling instrument – spatula; 16,6 cm	86
151 51 3657	Hladítko oboustranné jemné 3× lomené; 16,6 cm TiN	Plastic filling instrument TiN – spatula; 16,6 cm	86
151 56 0196	Cpátko oboustranné; 1,2/1,6 mm; 16,8 cm	Filling instrument – angled hollow handle; 1,2/1,6 mm; 16,8 cm	82
151 56 0197	Cpátko oboustranné; 1,2/1,6 mm; 16,8 cm TiN	Filling instrument – angled hollow handle TiN; 1,2/1,6 mm; 16,8 cm	82
151 56 0206	Cpátko oboustranné; 2,0/2,5 mm; 16,8 cm	Filling instrument – angled hollow handle; 2,0/2,5 mm; 16,8 cm	82
151 56 0207	Cpátko oboustranné; 2,0/2,5 mm; 16,8 cm TiN	Filling instrument – angled hollow handle TiN; 2,0/2,5 mm; 16,8 cm	82
151 56 0346	Hladítko se cpátkem fig. 3; 16,6 cm	Spatula – filling instrument hollow handle; 16,6 cm	84
151 56 0347	Hladítko se cpátkem fig. 3; 16,6 cm TiN	Spatula – filling instrument hollow handle TiN; 16,6 cm	84
151 56 0356	Hladítko se cpátkem; 1,0/1,5 mm; 16,4 cm	Spatula – filling instrument hollow handle; 1,0/1,5 mm; 16,4 cm	84
151 56 0466	Cpátko vlákna do sulku; 2 mm; 16,6 cm	Fibre filling instrument hollow handle; 2 mm; 16,6 cm	83
151 56 0516	Zavaděč retrakčních vláken (přední zuby), 2,5 mm; 16,8 cm	Retentive fibre instrument; 16,8 cm	83
151 56 0526	Zavaděč retrakčních vláken (zadní zuby), 2,5 mm; 16,8 cm	Retentive fibre instrument; 16,8 cm	83
151 56 0626	Hladítko oboustranné fig. 1; 16,6 cm	Spatula hollow handle; 16,6 cm	87
151 56 0627	Hladítko oboustranné fig. 1; 16,6 cm TiN	Spatula hollow handle tin; 16,6 cm TiN	87
151 56 0656	Hladítko oboustranné 3× lomené; 16,6 cm	Spatula 3× angled hollow handle; 16,6 cm	86
151 56 0696	Hladítko oboustranné; 1,5 mm; 16,6 cm	Spatula – filling instrument hollow handle; 1,5 mm; 16,6 cm	87
151 56 0706	Heidemann hladítko oboustranné fig. 1; 16,6 cm	Heidemann spatula hollow handle; 16,6 cm	87
151 56 0716	Heidemann hladítko oboustranné fig. 2; 16,9 cm	Heidemann spatula hollow handle; 16,9 cm	87
151 56 0726	Heidemann hladítko oboustranné fig. 2; 17,3 cm	Heidemann spatula hollow handle; 17,3 cm	87
151 56 0886	Nástroj na modelování výplně; 1,6/2,5 mm; 16,4 cm	Filling instrument hollow handle; 1,6/2,5 mm; 16,4 cm	89
151 56 1496	Wiland nástroj na výplně oboustranný; 16,6 cm	Wiland amalgam carver double-faced; 16,6 cm	88
151 56 3626	Hladítko oboustranné jemné fig. 1; 16,6 cm	Spatula hollow handle; 16,6 cm	87
151 56 3627	Hladítko oboustranné jemné fig. 1; 16,6 cm TiN	Spatula hollow handle TiN; 16,6 cm TiN	87
151 56 3636	Hladítko oboustranné jemné fig. 2; 16,6 cm	Spatula hollow handle; 16,6 cm	87
151 56 3637	Hladítko oboustranné jemné fig. 2; 16,6 cm TiN	Spatula hollow handle TiN; 16,6 cm TiN	87
151 56 3656	Hladítko oboustranné jemné 3× lomené; 16,6 cm	Spatula 3× angled hollow handle; 16,6 cm	86
152	Ortodoncie, Zubní náhrady	Orthodontic, Tooth Replacement	
152 52 1900	Zesilovací mřížka zlacená; 60×54×12 mm	Mesh strengthener; 60×54×12 mm	118
152 52 1910	Zesilovací mřížka nerezová; 60×54×12 mm	Mesh strengthener; 60×54×12 mm	118
154	Otiskovací lžice	Impression Trays	
154 52 0110	Lžice otiskovací; BOX1	Impression tray; BOX1	119
154 52 0120	Lžice otiskovací; BOX2	Impression tray; BOX2	119
154 52 0130	Lžice otiskovací; BOX3	Impression tray; BOX3	119
154 52 0140	Lžice otiskovací; BOX4	Impression tray; BOX4	119
154 52 0260	Lžice otiskovací; FX1	Impression tray; FX1	119
154 52 0270	Lžice otiskovací; FX2	Impression tray; FX2	119
154 52 0280	Lžice otiskovací; FX3	Impression tray; FX3	119
154 52 0290	Lžice otiskovací; FX4	Impression tray; FX4	119
154 52 0360	Lžice otiskovací; DHX1	Impression tray; DHX1	120
154 52 0370	Lžice otiskovací; DHX2	Impression tray; DHX2	120
154 52 0380	Lžice otiskovací; DHX3	Impression tray; DHX3	120
154 52 0460	Lžice otiskovací; DDX1	Impression tray; DDX1	120
154 52 0470	Lžice otiskovací; DDX2	Impression tray; DDX2	120
154 52 0480	Lžice otiskovací; DDX3	Impression tray; DDX3	120
154 52 0550	Lžice otiskovací; PPX	Impression tray; PPX	119
154 52 0560	Lžice otiskovací; PLX	Impression tray; PLX	119
154 52 0600	Lžice otiskovací korunková	Crown impression tray	119
154 52 0610	Lžice otiskovací; FOX1	Impression tray; FOX1	120
154 52 0620	Lžice otiskovací; FOX2	Impression tray; FOX2	120
154 52 0630	Lžice otiskovací; FOX3	Impression tray; FOX3	120
154 52 0640	Lžice otiskovací; FOX4	Impression tray; FOX4	120
154 52 0660	Lžice otiskovací; UUX1	Impression tray; UUX1	120
154 52 0670	Lžice otiskovací; UUX2	Impression tray; UUX2	120

číslo – number	název	item	strana – page
154 52 0680	Lžice otiskovací; UUX3	Impression tray; UUX3	120
154 52 0690	Lžice otiskovací; UUX4	Impression tray; UUX4	120
154 52 0790	Lžice otiskovací; BOXC3	Impression tray; BOXC3	120
154 52 0820	Lžice otiskovací; FXC2	Impression tray; FXC2	120
154 52 0830	Lžice otiskovací; FXC3	Impression tray; FXC3	120
154 52 1550	Soubor otiskovacích lžic perforovaných; 9 ks	Set of impression perforated trays; 9 pcs	119
154 52 1650	Soubor otiskovacích lžic dětských perforovaných; 6 ks	Set of impression perforated trays for children	120
154 52 9010	Lžice otiskovací-nerez; H1	Impression tray-stainless steel; H1	119
154 52 9011	Lžice otiskovací-nerez; H2	Impression tray-stainless steel; H2	119
154 52 9012	Lžice otiskovací-nerez; H3	Impression tray-stainless steel; H3	119
154 52 9013	Lžice otiskovací-nerez; H4	Impression tray-stainless steel; H4	119
154 52 9014	Lžice otiskovací-nerez; D1	Impression tray-stainless steel; D1	119
154 52 9015	Lžice otiskovací-nerez; D2	Impression tray-stainless steel; D2	119
154 52 9016	Lžice otiskovací-nerez; D3	Impression tray-stainless steel; D3	119
154 52 9017	Lžice otiskovací-nerez; D4	Impression tray-stainless steel; D4	119
154 52 9018	Lžice otiskovací-nerez; HX1	Impression tray-stainless steel; HX1	119
154 52 9019	Lžice otiskovací-nerez; HX2	Impression tray-stainless steel; HX2	119
154 52 9020	Lžice otiskovací-nerez; HX3	Impression tray-stainless steel; HX3	119
154 52 9021	Lžice otiskovací-nerez; HX4	Impression tray-stainless steel; HX4	119
154 52 9022	Lžice otiskovací-nerez; DX1	Impression tray-stainless steel; DX1	119
154 52 9023	Lžice otiskovací-nerez; DX2	Impression tray-stainless steel; DX2	119
154 52 9024	Lžice otiskovací-nerez; DX3	Impression tray-stainless steel; DX3	119
154 52 9025	Lžice otiskovací-nerez; DX4	Impression tray-stainless steel; DX4	119
155	Nástroje modelovací	Modelling Instruments	
155 52 0180	Le Cron nástroj modelovací; 17,5 cm	Le Cron modelling instrument; 17,5 cm	115
155 52 0212	Nůž modelovací; 13,0 cm	Modelling knife; 13,0 cm	115
155 52 0222	Nůž modelovací; 17,4 cm	Modelling knife; 17,4 cm	115
156	Matrice	Matrix Bands	
156 52 0010	Ivory matrice na tvarování výplní malá; 2,5 cm	Ivory matrix band small; 2,5 cm	94
156 52 0020	Ivory matrice na tvarování výplní střední; 3,6 cm	Ivory matrix band medium; 3,6 cm	94
156 52 0030	Ivory matrice na tvarování výplní velká; 3,5 cm	Ivory matrix band large; 3,5 cm	94
156 52 0050	Ivory napínač matric; 7,0 cm	Ivory matrix retainer; 7,0 cm	94
156 52 0300	Napínač matric; 6,4 cm	Universal retainer; 6,4 cm	95
156 91 0001	Matrice pásková; 5 mm; 1 m	Matrix band; 5 mm; 1 m	95
156 91 0002	Matrice pásková; 6 mm; 1 m	Matrix band; 6 mm; 1 m	95
156 91 0003	Matrice pásková; 7 mm; 1 m	Matrix band; 7 mm; 1 m	95
157	Kyvety, třmeny, lisy	Flasks, Claps, Presses	
157 52 0030	Třmen pro jednu kyvetu; 17,0 cm	Clap for one flask; 17,0 cm	117
157 52 0040	Třmen pro dvě kyvety; 22,5 cm	Clap for two flasks; 22,5 cm	117
157 52 0050	Třmen pro tři kyvety; 28,0 cm	Clap for three flasks; 28,0 cm	117
159	Pomocné vybavení	Auxiliary Devices	
159 53 0050	Nádobka na vatu s pružinou	Cotton wool box with spring	123
159 53 0060	Nádobka na vatové odpadky	Cotton wool container	123
159 53 0100	Držátko ubrousku řetízkové, UH svorky; 50 cm	Napkin holder with metal chain; 50 cm	123
159 53 0110	Držátko ubrousku UH, kovové svorky; 50 cm	Napkin holder; 50 cm	123
159 53 0120	Držátko ubrousku řetízkové, kovové svorky 32 cm	Napkin holder with metal chain; 32 cm	123

Jmenný rejstřík – český

Alphabetical index – Czech



A			
Adson pinzeta anatomická	66		
Adson pinzeta chirurgická	66		
B			
Babcock svorka chirurgická	44		
Backhaus svorka na prádlo	46		
Backhaus-Clip svorka na prádlo	46		
Barry páka extrakční	25		
Bein páka extrakční	21, 22		
Blumenthal kleště štípací na kosti	16		
Bowmann pátradlo oční	71		
Boynton jehelec oční	48		
Boynton jehelec oční tvrdokov	50		
Brünnings lopatka na jazyk	72		
Buchwald lopatka na jazyk	72		
C			
Castroviejo jehelec	51		
Castroviejo jehelec mikro	51		
Castroviejo nůžky na duhovku	60		
Castroviejo nůžky oční	60		
Cleveland kleště štípací na kosti	16		
Collin kleště na jazyk okénkované	19		
Collin kleště tamponové	19		
Cpátko amalgamu oboustranné	80		
Cpátko kombinované oboustranné	81		
Cpátko kompozitních materiálů	80		
Cpátko kopytkové	81		
Cpátko kořenové jednostranné	82		
Cpátko kuličkové s hladítkem	85		
Cpátko oboustranné	80–82		
Cpátko oboustranné oválné	80		
Cpátko vlákna do sulku	83		
Crile jehelec jemný	48, 50		
Cushing háček jemný	31		
Č			
Čepelka skalpelová	41		
D			
De Bakey pinzeta atraumatická	67		
De Bakey-Mosquito svorka atraumatická	45		
De Bakey-Pean svorka atraumatická	45		
De Bakey-Rankin svorka atraumatická	45		
Desmarres háček jemný	31		
Dieffenbach skalpel oční	39		
Discoid-Cleoid nástroj na výplň	90		
Dláto žlábkové	28		
Drápek na zubní kámen	104		
Držák	123		
Držátko skalpelových čepelek	40		
Držátko ubrousku řetízkové	123		
Držátko ubrousku UH	123		
Držátko zubního zrcátka	73		
E			
Exkavátor jednostranný	77		
Exkavátor oboustranný	78		
F			
Flohr páka extrakční	22		
Frahm nástroj na modelování výplně	88		
Freer páčidlo na nosní přepážku	20		
Freer páčidlo nosní	20		
Friedman kleště štípací na kosti	16		
Furkační kyreta	103		
G			
Gillies pinzeta chirurgická	66		
Goldman-Fox nůžky na dásně	54		
Gomel nůžky mikro	61		
Gracey kyreta	100, 102		
Graefe pinzeta fixační	68		
Graefe pinzeta oční	68		
H			
Háček na rány	30		
Háček oční	32		
Háček pro plastiku	32		
Hák intraorální	35		
Hák resekcí	34		
Halsted-Mosquito svorka na cévy	43		
Hartmann svorka	43		
Heidemann hladítko	87		
Heister rozvěrač úst	36		
Heywood-Smith kleště tamponové	19		
Hladítko oboustranné	86, 87		
Hladítko pružné	87		
Hladítko se cpátkem	84		
I			
Ivory matrice na tvarování	94		
Ivory napínač matric	94		
J			
Jacobson jehelec mikro	51		
Jansen kleště štípací	17		
Jehelec hloubkový	48, 49		
Jehelec s vnitřním uzávěrem	49		
Jennings rozvěrač úst	36		
Jeweler pinzeta	64		
Joseph háček na rány	30		
Joseph pilník	27		
K			
Kazeta pro stomatologické nástroje	125		
Kazeta s držákem	125		
Kladívko chirurgické kovové	29		
Kladívko laboratorní ocelové	116		
Kleště extrakční	11–15		
Kleště k odstranění kořenových nástrojů	15		
Kleště laboratorní	113		
Kleště na kelímky	113		
Kleště štípací	18		
Kleště štípací na drát	113		
Krabička kulatá	126		
Krabička na katetry	126		
Krabička s bočními prohlubněmi	126		
Krabička s poklopem	126		
Krabička s příhrádkami	126		
Krabička s rovným víkem	126		
Krabička s vypouklým víčkem	126		

Krabička sterilizační	126	Olsen-Hegar jehelec/nůžky	49
L		P	
Langenbeck hák na rány	35	Páčidlo na nosní přepážku	20
Langenbeck chránič prstu	35	Páka extrakční	21, 23
Langenbeck páčidlo	20	Pásek separační diamantovaný	91
Langenbeck škrabka	26	Pásek separační hladký	91
Le Cron nástroj modelovací	115	Pátradlo zubní háčkové	71
Lecluse páka extrakční	25	Pátradlo zubní obloukové	71
List k pilce upínací stomatologické	112	Pátradlo zubní vyhnuté	71
Lister kleště tamponové	19	Peers svorka na prádlo	47
Lister nůžky na obvazy	53	Pilník	27
Liston kleště štípací	18	Pinzeta anatomická	62
Littauer nůžky pro ligaturu	55	Pinzeta cévní atraumatická	67
Löbker kleště na jazyk	19	Pinzeta chirurgická	67
Lopatka na cement	93	Pinzeta laboratorní	111
Lopatka na míchání otiskovacích hmot	93	Pinzeta na kořenové čípky	64
Lopatka na sádru	114	Pinzeta šicí	65
Lorna svorka na prádlo	47	Pinzeta zkřížená	115
Luer kleště štípací na kosti	16, 17	Pinzeta zkřížená se šroubovákem	115
Luniatschek zavaděč drenů	52	Pinzeta zubní	62
Lžice otiskovací	119, 120	Pinzeta zubní chirurgická	65
Lžice otiskovací korunková	119	Pistole na amalgam s kovovým pístem	92
Lžička laboratorní	114	Planátor	91
Lžička oboustranná	119	Přecechtěl škrabka nosní	26
Lžička ostrá	119		
Lžička ostrá oboustranná	119	Q	
M		Quinby nůžky na dásěň	54
Mathieu jehelec	48		
Mathieu jehelec	50	R	
Mathieu jehelec jemný	50	Rám upínací pilky stomatologické	112
Matrice pásková	94	Reynolds nůžky preparační	55
Micro-Mosquito svorka na cévy	42	Roeder svorka na prádlo	47
Middeldorpf hák na rány okénkovo	33	Roser-König rozvěrač úst	35
Mini Gracey kyreta	100, 102	Rouška textilní zelená	134
Mini-Friedman kleště štípací na kosti	16	Roux hák	34
Mini-Langenbeck háček jemný	31	Ryder jehelec	49
Mod. Bonn nůžky extra jemné	58		
Mosquito-Halsted svorka na cévy	42	S	
N		Sanvenero nůžky preparační	55
Nabers furkační sonda	99	Sapin nástroj na modelování výplní	88
Nádobka kovová	123	Scaler oboustranný	102, 103
Nádobka medicínská kovová	123	Semken pinzeta anatomická	66
Nádobka na vatové odpadky	123	Schlemmer páka extrakční	23
Nádobka na vatu s pružinou	123	Sonda parodontologická	99
Nádobka oválná – emitní miska	135	Sonda parodontologická s pátradlem	99
Napínač matric	94	Soubor otiskovacích lžic dětských	120
Nástroj na modelování výplní	88–90	Soubor otiskovacích lžic perforovaných	119
Nástroj na plastické výplně	88–90	Soubor parodontologických nástrojů	102
Nástroj na snímání korunek	96	Spencer nůžky pro ligaturu	55
Nástroj na zubní kámen	107	Srpek na zubní kámen	104, 105
Nástroj na zubní kámen	107	Standard nůžky chirurgické	56, 57
Nástroj pro výplně	88–90	Standard pinzeta anatomická	64
Nosič amalgamu	79	Standard pinzeta chirurgická	64
Noyes nůžky na duhovku	60	Standard pinzeta chirurgická jemná	65
Nůž modelovací	115	Stellbrink kleště štípací na kosti	16
Nůž na dásěň oboustranný	54	Svorka na separační pásky	91
Nůž na sádru s otvíračem květ	114		
Nůžky	54	Š	
Nůžky chirurgické	56	Škrabka na operaci slzného vaku	26
Nůžky lomené	59	Škrabka na zubní kámen	105
Nůžky mikro	61	Špinar páka extrakční	24
Nůžky na dásěň	54		
Nůžky na korunky	112	T	
Nůžky rovné	54	Tácek	127
Nůžky zahnuté	54	Tácek dentální	127
O		Tácek hluboký	127
Obtahovací kamínek na ostření kyret	103	Tácek s drážkami	127
Oehler pinzeta chirurgická	66	Testovací tyčinka PMMA	103
		Tohoku-Japan svorka na prádlo	47

Toulec na kleště	124
Toulec na pinzety	124
Toulec na podávkové kleště	124
Třmen pro kyvety	117

V

W

Wagner nůžky jemné	58
Walton nůžky jemné	54
West dláto žlábkové	28
White páka extrakční	24, 25
Whitehead rozvěrač úst	36
Wiland nástroj na výplně	88
Williger páčidlo	20
Williger škrabka	26

Z

Zavaděč retrakčních vláken	83
Zesilovací mřížka	118
Zešikmovač gingiválních okrajů	106
Zrcátko intraorální	72
Zrcátko zubní ploché	73
Zrcátko zubní zvětšovací	73

Jmenný rejstřík – anglický

Alphabetical index – English



A

Adson forceps	66
Amalgam condenser	89
Amalgam gun	92

B

Babcock tissue seizing forceps	44
Backhaus towel forceps	46
Backhaus-Clip towel forceps	46
Barry root elevator	25
Bein root elevator	21, 22
Black scaler	105
Blade of stomatological saw	112
Blumenthal bone ronguers	16
Bone curette double-faced	37
Bone rongeurs	18
Bowl	125
Bowmann eye probe	71
Box	126, 127
Box round	125
Boynton eye needle holder	48
Brünnings tongue spatula	72
Buchwald tongue spatula	72

C

Carrier hollow handle	79
Cassette	125
Cassette with holder	125
Castroviejo eye scissors	60
Castroviejo iris scissors	60
Castroviejo micro-needle holder	51
Castroviejo needle holder	51
Cement spatula	93, 114
Chisel	28
Clap for flasks	117
Cleveland bone ronguers	16
Collin dressing forceps	19
Collin tongue holding forceps	19
Container	132
Cotton wool box with spring	123
Cotton wool container	123
Crile needle holder	48, 50
Crown impression tray	119
Crown remover	96
Crown scissors	112
Crucible forceps	113
Cushing delicate hook	30
Cutting instrument	107

D

De Bakey atrauma forceps	67
De Bakey-Mosquito atrauma forceps	45
De Bakey-Pean atrauma forceps	45
De Bakey-Rankin atrauma forceps	45
Delicate hook	30
Dental forceps	63
Dental mirror	73
Dental probe	71
Dental tray	127
Desmarres delicate hook	30
Dieffenbach knife	39
Discoid-Cleoid filling instrument	90
Dissection micro scissors	61

E

Excavator curved	77
Excavator double-faced	77, 78
Excavator straight	77
Extraction forceps	11–15
Eye hook	32

F

Fibre filling instrument	83
Filling instrument	80–82, 88, 89
Flohr root elevator	22
Forceps for extraction of root instruments	15
Forceps quiver with stand	124
Frahm filling instrument	88
Frahm modelling instrument	88
Frame of stomatological saw	112
Freer nasal elevator	20
Freer septum elevator	20
Friedman bone ronguers	16
Furcation curette	103

G

Gillies tissue forceps	66
Gingival margin trimmer	106
Goldman-Fox scissors	54
Gomel dissection micro scissors	61
Gracey curette	100, 102
Graefe eye forceps	68
Graefe fixation forceps	68
Gum scissors	54

H

Halsted-Mosquito artery forceps	43
Hartmann forceps	43
Heidemann spatula	87
Heister mouth retractor	36
Heywood-Smith sponge holding forceps	19
Holder	125

I

Impression tray	119, 120
Intraolar hook	35
Intraoral mirror	72
Ivory matrix band	94
Ivory matrix retainer	94

J

Jacobson micro-needle holder	51
Jansen mastoid forceps	17
Jennings mouth retractor	36
Jeweler forceps	66
Joseph delicate hook	30
Joseph rasp	27

L

Laboratory forceps	111
Laboratory mallet	116
Laboratory spoon	114
Lachrymal sac raspatory	26
Langenbeck elevator	20
Langenbeck finger protector	35

Langenbeck raspatory	26
Langenbeck retractor	34
Le Cron modelling instrument	115
Lecluse root elevator	25
Lister bandage scissors	53
Lister sinus forceps	19
Liston bone rongeurs	18
Littauer ligature scissors	55
Löbker tongue holding forceps	19
Lorna towel forceps	47
Luer bone rongeurs	16, 17
Luniatschek drain introducer	52

M

Mathieu needle holder	48, 50
Matrix band	95
Mesh strengthener	118
Micro-Mosquito artery forceps	43
Middeldorpf retractor	33
Mini Gracey curette	101, 102
Mini-Friedman bone ronguers	16
Mini-Langenbeck delicate hook	31
Mirror handle	73
Mixing spatula	93, 114
Mod. Bonn extra delicate scissors	58
Modelling instrument	88–90
Modelling knife	115
Mosquito-Halsted artery forceps	42
Mouth mirror	73

N

Nabers furcation probe	99
Napkin holder	123
Needle holder	48, 49
Non-traumatic forceps	67
Noyes iris scissors	60

O

Oehler tissue forceps	66
Olsen-Hegar needle holder/scissors	49
Operating scissors	57

P

Peers towel forceps	47
Periodontal and dental probe	99
Periodontal probe	99
Plaster knife	114
Plaster spatula	114
Plastic filling instrument	90
Plastic filling instrument	86, 87, 90
Plastic filling instrument – carrier	80
Plastic filling instrument – plugger	80–82, 89
Plastic filling instrument – spatula	86, 87, 90
Plastic filling instrument – spatula-plugger	84, 85
Plastic hook	32
Plastic test stick	103
Přecechtěl nasal raspatory	26

Q

Quinby gum scissors	54
Quiver for forceps	124

R

Rasp	27
Resection hook	34
Retentive fibre instrument	83
Reynolds dissecting scissors	55
Roeder towel forceps	47
Root elevator	23–25

Root suppository forceps	62
Roser-König mouth retractor	36
Roux retractor	34
Ryder needle holder	49

S

Sanvenero dissecting scissors	55
Sapin filling instrument hollow handle	88
Sapin modelling instrument	88
Scaler	104–105
Scaler double-faced	104–105
Scalpel blade	41
Scalpel handle	40
Scissors	59
Seal for sterilizing containers	133
Semken dissecting forceps	66
Separative strip diamond	91
Separative strip smooth	91
Septum nasal elevator	20
Set of impression perforated trays	119
Set of impression perforated trays for children	120
Set of mini periodontal instruments	102
Set of periodontal instruments	102
Sharp spoon	38
Sharpening stone for curretes	103
Schlemmer root elevator	23
Small set container	122
Spatula – filling instrument	84, 86, 87
Spencer ligature scissors	55
Standard operating scissors	56, 57
Stellbrink bone ronguers	16
Sterilization box	126
Strip clamp	91
Surgical mallet	29
Suture tying forceps	65
Špinar root elevator	24

T























Tissue forceps	64, 65
Tissue forceps	63–65
Tohoku-Japan towel forceps	47
Tray	127
Tweezer quiver with stand	124

U

Universal retainer	93
--------------------	----

W

Wagner fine scissors	58
Walton fine scissors	58
West gouge grooved	28
Whitehead mouth retractor	36
Wiland amalgam carver	88
Williger elevator	20
Williger raspatory	26
Wire cutting forceps	113

	použit do	use by
	datum výroby	date of manufacture
	výrobce	manufacturer
	nepoužívat opětovně	do not re-use
	neprovádět opětovnou sterilizaci	do not resterilize
	nepoužívat, jestliže je balení poškozeno	do not use if package is damaged
	otevřené balení nebude nahrazeno	opened packages are not replaced
	set, souprava	assortment
	seznamte se s návodem k použití kvůli důležitým varovným informacím	caution, consult accompanying documents
	nesterilní	non sterile
	doporučené otáčky za minutu, doporučená frekvence otáčení XXX-XXX min ⁻¹	recommended rotation speed
	kód dávky	batch code
	katalogové číslo	catalogue number
	množství	quantity
	označuje kontrolní materiál	control (indicates a control material)
	sterilní	sterile
	sterilizováno ozářením	sterilised using irradiation
	sterilizováno ethylenoxidem	sterilised using ethylene oxide
	sterilizováno aseptickou technologií	sterilised using aseptic processing techniques
	diagnostický zdravotnický prostředek in vitro	in vitro diagnostic medical device
	globální nomenklatura zdravotnických prostředků	global medical device nomenclature code
	seznamte se s návodem k použití	consult instructions for use

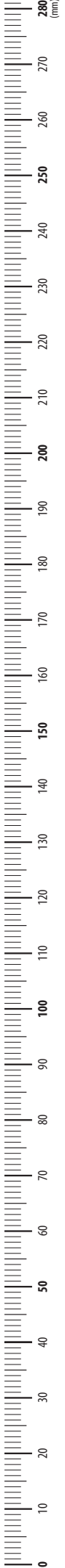

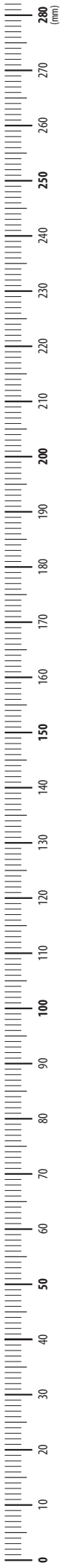

A series of horizontal lines extending across the page, providing a template for writing or drawing. The lines are evenly spaced and correspond to the millimeter markings on the ruler.



MEDIN, a.s.
Vlachovická 619
Nové Město na Moravě
CZ 592 31
Czech Republic
IČ 43378030
DIČ CZ43378030

EXPORT
phone: +420 566 684 336
fax: +420 566 684 385
e-mail: export@medin.cz

www.medin.cz
www.medin.eu
PRODEJ ČESKÁ REPUBLIKA
tel.: 566 684 327
fax: 566 684 384
e-mail: prodej@medin.cz



2020