

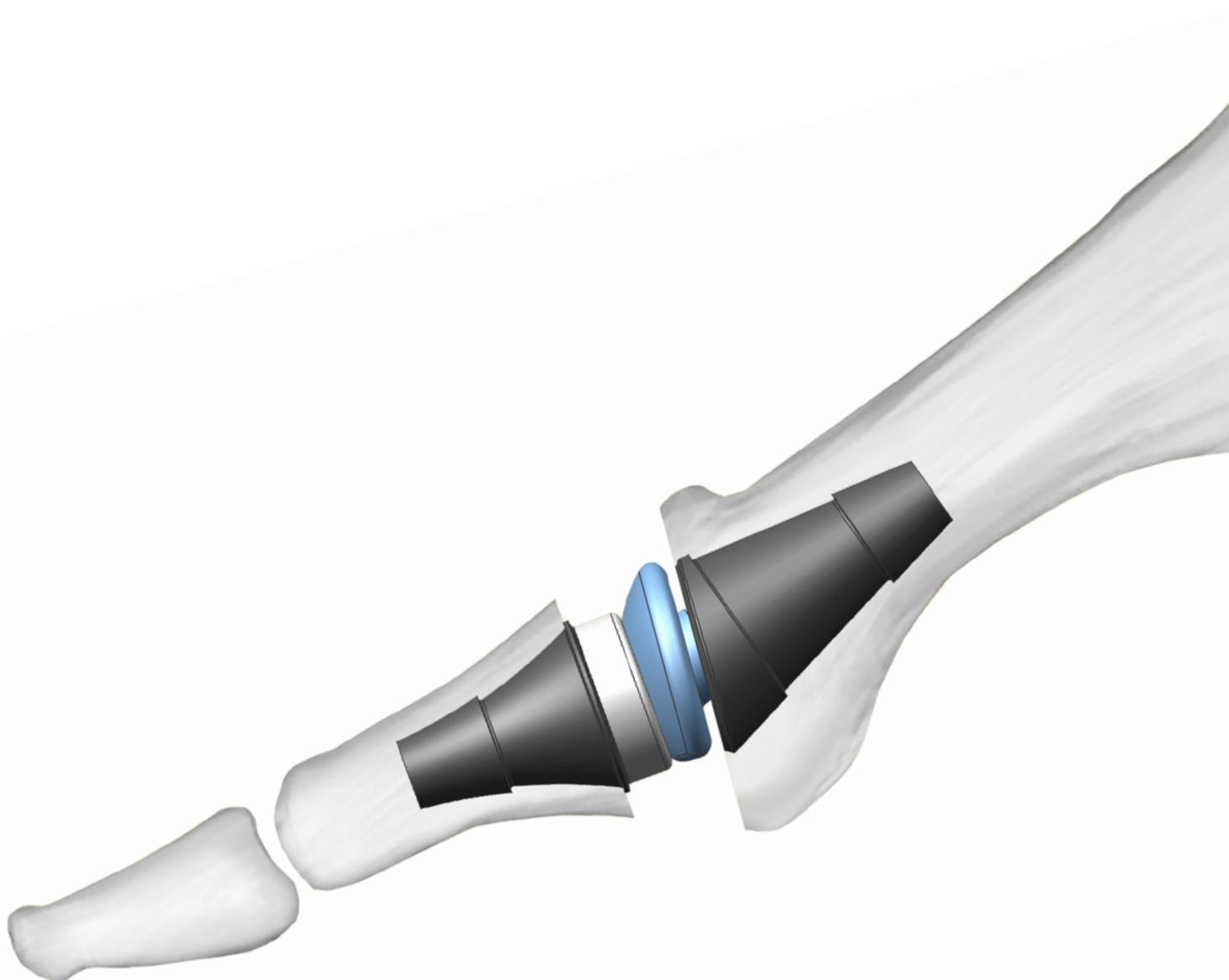

NÁHRADY MALÝCH KLOUBŮ SMALL JOINT REPLACEMENTS



NÁHRADY MALÝCH KLOUBŮ

SMALL JOINT REPLACEMENTS



Náhrady malých kloubů

Náhrada kloubu prstního silikonová

Náhrada MTP kloubu palce nohy

Náhrada trapézia silikonová

Náhrada šlachy silikonová dočasná

Small joint replacements

MCP/PIP joint replacement

MTP joint replacement

CMC joint replacement

Tendon replacement temporary

3

4-5

6

6

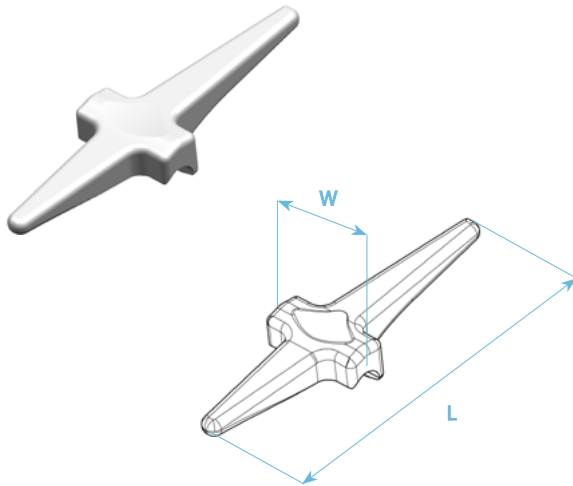

Náhrada kloubu prstního silikonová
MCP/PIP joint replacement

- silikon Nusil MED-4550
- necementovaná/cementless

	velikost/size	W	L
Z06110-0200-12035	2	12 mm	35 mm
Z06110-0300-13043	3	13 mm	43 mm
Z06110-0400-14049	4	14 mm	49 mm
Z06110-0500-15055	5	15 mm	55 mm
Z06110-0600-16062	6	16 mm	62 mm
Z06110-0700-17068	7	17 mm	68 mm
Z06110-0800-18075	8	18 mm	75 mm

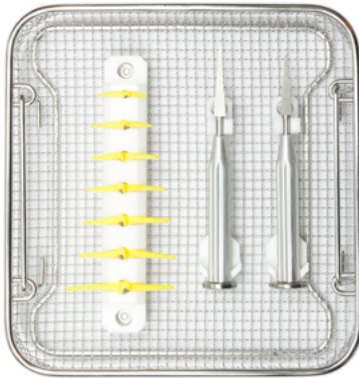

Instrumentárium pro náhradu kloubu prstního
MCP/PIP joint replacement - instrument set

- včetně sterilizačního kontejneru
- including sterilization container

Z76130-0000-00

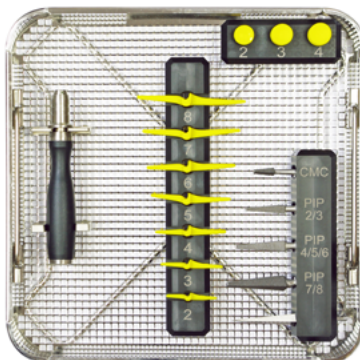

Instrumentárium pro náhradu kloubů prstních
MCP/PIP and CMC joint replacement - instrument set

- včetně sterilizačního kontejneru
- including sterilization container

Z76130-0000-00



NÁHRADA MTP KLOUBU PALCE NOHY
MTP JOINT REPLACEMENT

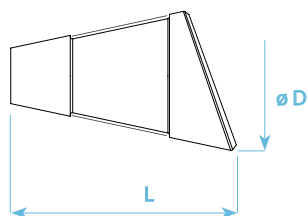

Komponenta metatarzální
Metatarsal component

- Ti6Al4V ELI (ISO 5832-3) + HAp
- necementovaná/cementless

	velikost/size	ø D	L
Z06401-0202-13019	S	13 mm	19 mm
Z06401-0302-14021	M	14 mm	21 mm
Z06401-0402-16023	L	15,5 mm	23 mm
Z06401-0502-17025	XL	16,5 mm	25,4 mm

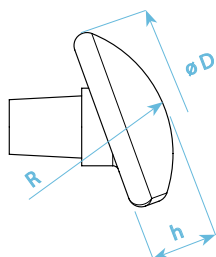

Hlavice metatarzální
Metatarsal head

- CoCrMo (ISO 5832-12)

	velikost/size	ø D	h	R
Z06400-0105-00010	1	15 mm	4,5 mm	10 mm
Z06400-0205-00010	2	16 mm	5 mm	10 mm
Z06400-0305-00010	3	17 mm	6 mm	10 mm

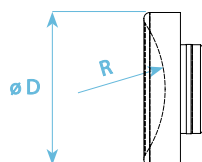

Vložka falangeální TOTAL
Phalangeal insert TOTAL

- UHMWPE (ISO 5834-2)

	velikost/size	ø D	R
Z06400-0104-10011	1	11 mm	10 mm
Z06400-0104-10013	2	13 mm	10 mm
Z06400-0204-10014	3	14 mm	10 mm

NÁHRADA MTP KLOUBU PALCE NOHY
MTP JOINT REPLACEMENT

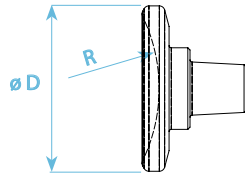

Jamka falangeální HEMI
Phalangeal insert HEMI

• CoCrMo (ISO 5832-12)

	velikost/size	$\varnothing D$	R
Z06400-0003-13125	1	13 mm	12,5 mm
Z06400-0003-15150	2	15 mm	15 mm
Z06400-0003-17185	3	17 mm	18,5 mm

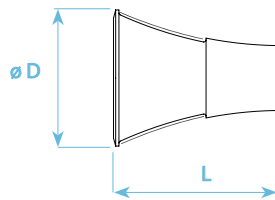

Komponenta falangeální
Phalangeal component

• Ti6Al4V ELI (ISO 5832-3) + HAp
• necementovaná/cementless

	velikost/size	$\varnothing D$	L
Z06401-0101-11013	S	11 mm	12,5 mm
Z06401-0101-12014	M	12 mm	13,5 mm
Z06401-0101-13016	L	12,5 mm	15 mm
Z06401-0101-15016	XL	14,5 mm	16 mm

Instrumentarium pro náhradu MTP kloubu palce nohy
MTP joint replacement - instrument set

• bez sterilizačního kontejneru
• sterilization container not included

Z76410-0000-00

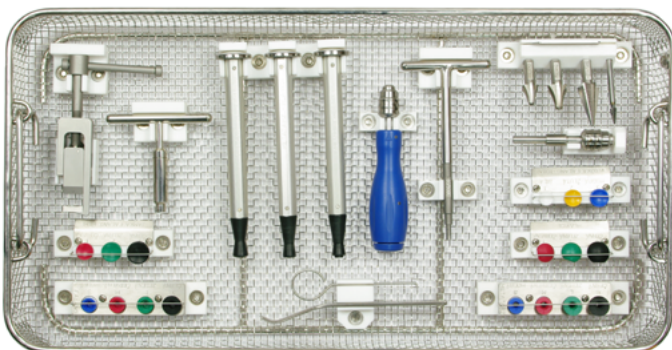

SILIKONOVÉ IMPLANTÁTY
SILICONE IMPLANTS

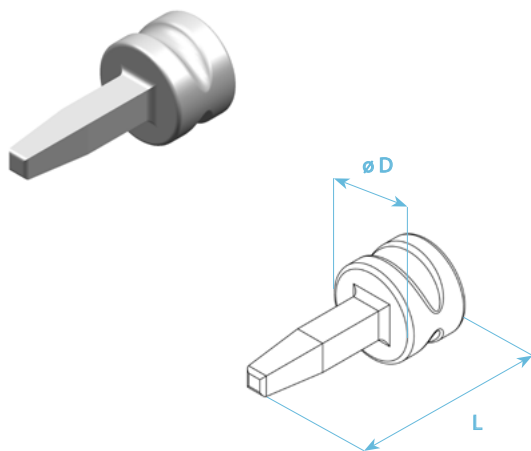

Náhrada trapezia silikonová
CMC joint replacement

- silikon Nusil MED-4550
- necementovaná/cementless

	velikost/size	ø D	L
Z06120-0000-13028	2	13 mm	28 mm
Z06120-0000-14031	3	14 mm	31 mm
Z06120-0000-15035	4	15 mm	35 mm

SILIKONOVÉ IMPLANTÁTY
SILICONE IMPLANTS

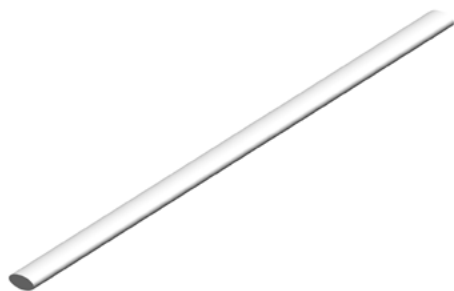

Náhrada šlachy silikonová dočasná
Tendon replacement temporary

- silikon Nusil MED-4550

	velikost/size	Wxh	L
Z06230-0000-05120	5x2,5x120	5x2,5 mm	120 mm
Z06230-0000-05180	5x2,5x180	5x2,5 mm	180 mm
Z06230-0000-05220	5x2,5x220	5x2,5 mm	220 mm
Z06230-0000-06120	6x3x120	6x3 mm	120 mm
Z06230-0000-06180	6x3x180	6x3 mm	180 mm
Z06230-0000-06220	6x3x220	6x3 mm	220 mm

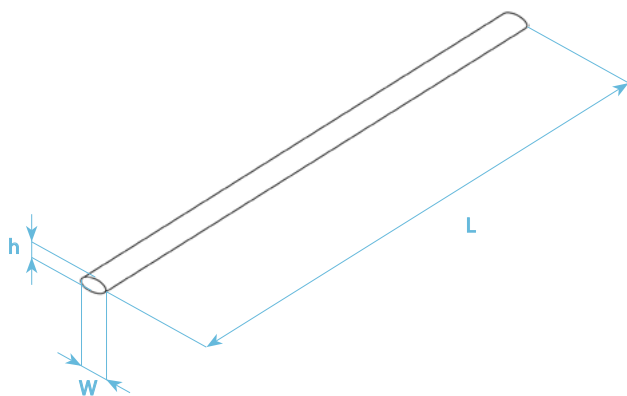



POUŽITÉ ZKRATKY A SYMBOLY

MCP	metakarpofalangeální
PIP	proximální interfalangeální
CMC	karpometakarpální
∅	průměr
MTP	metatarzofalangeální
Ti6Al4V	slitina titanu, hliníku a vanadu
ELI	extra-low interstitials
ISO	International Organization for Standardization
HAp	hydroxylapatit
CoCrMo	slitina kobaltu chormu a molybdenu
UHMWPE	Ultra High Molecular Weight Polyethylene
FeNiCr	implantátová nerezová ocel

USED ABBREVIATIONS AND SYMBOLS

MCP	metacarpophalangeal
PIP	proximal interphalangeal
CMC	carpometacarpal
∅	diameter
MTP	metatarsophalangeal
Ti6Al4V	titanium, aluminium and vanadium alloy
ELI	extra-low interstitials
ISO	International Organization for Standardization
HAp	hydroxylapatite
CoCrMo	cobalt, chromium and molybdenum alloy
UHMWPE	Ultra High Molecular Weight Polyethylene
FeNiCr	stainless steel for implants

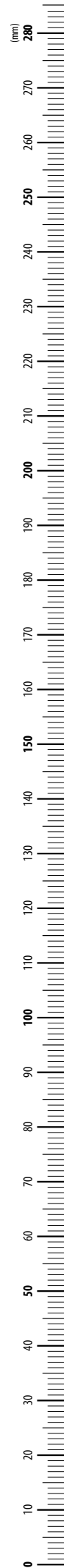



VÝROBA A VÝVOJ

ProSpon, spol. s r.o.
Jiřího Voskovce 3206
272 01 Kladno
Česká republika

PRODEJ ČESKÁ REPUBLIKA

tel: +420 312 247 763
e-mail: prospon@prospon.cz

■ www.prospon.cz

2024